



# Bearing Protection Handbook

Best Practices for Bearing Protection in New and Repaired Motors, Testing In-Service Motors, and Inspecting Damaged Motor Bearings



Register your motor for the  
**AEGIS 2-Year Warranty Against Bearing Fluting Damage**



**Electro  
Static  
Technology™**  
An ITW Company

## COMPANY INFORMATION

Electro Static Technology, An ITW Company, is a global manufacturer and inventor of AEGIS® Shaft Grounding Rings used in electric motors and other rotating equipment to safely discharge variable frequency drive (VFD) voltages to ground. AEGIS® Shaft Grounding Ring technology is installed in all ranges of motors from fractional horse power to large medium voltage motors used in virtually all commercial and industrial applications.

AEGIS® Shaft Grounding Ring technology is the only technology that combines both contact and non-contact nanogap technology to reliably protect bearings from electrical discharges that cause pitting, frosting and fluting damage. AEGIS® Ring technology uses proprietary conductive micro fibers arranged circumferentially around the motor shaft and secured in our patented AEGIS® FiberLock™ channel which protects them during operation. The following patents apply: 8199453, 8169766, 7193836, 7136271, 7528513, 7339777, and other patents pending.

Electro Static Technology is proud to be an ISO 9001:2015 company. Certificate Number: 17116

## 2-YEAR EXTENDED WARRANTY

Electro Static Technology (EST, AEGIS®) guarantees that AC induction motor bearings will not fail from electrical fluting damage when AEGIS® Shaft Grounding Rings have been installed with new bearings in accordance with EST's recommended best practices, as published in the AEGIS® Bearing Protection Handbook (current edition). See page 55 for more information about the 2-Year Extended Warranty, or visit [www.est-aegis.com](http://www.est-aegis.com).

**Register your motor at [www.est-aegis.com/warranty](http://www.est-aegis.com/warranty)**

Units are guaranteed for one year from date of purchase against defective materials and workmanship. Replacement will be made except for defects caused by abnormal use or mishandling. All statements and technical information contained herein, or presented by the manufacturer or their representative are rendered in good faith. User must assume responsibility to determine suitability of the product for intended use. The manufacturer shall not be liable for any injury, loss or damage, direct or consequential arising out of the use, or attempt to use the product.

## SAFETY



Follow all workplace safety policies and procedures applicable to electric motor repair and for all hazardous operations. Wear all applicable personal protective equipment (PPE) required by the applicable law. Employees should be informed of the relevant safety rules and employers should enforce compliance. The manufacturer shall not be liable for any injury, loss or damage, direct or consequential arising out of the use, or attempt to use the product or procedures described in this manual.

© 2018 Electro Static Technology, An ITW Company, All rights reserved.

Artwork and layout by Joanne Audet, Electro Static Technology

No part of this book may be reproduced without permission in writing from Electro Static Technology, except by a reviewer who may quote brief passages or reproduce illustrations in a review with appropriate credit; nor may any part of this book be reproduced, stored in a retrieval system, or transmitted in any form or by any means - electronic, photocopying, recording, or other-without permission in writing from Electro Static Technology.

This book is generally reviewed every year and updated. Comments and suggestions are invited. Any errors or omissions in the data should be brought to the attention of the Editor. Additions and corrections to the Handbook in print will be in the Handbook published the following printed edition and, as soon as verified, on the Electro Static Technology website.

Disclaimer - Application notes are intended as general guidance to assist with proper application of AEGIS® Shaft Grounding Rings to protect motor bearings. All statements and technical information contained in the application notes are rendered in good faith. User must assume responsibility to determine suitability of the product for its intended use.

# TABLE OF CONTENTS

Introduction to Bearing Currents	4-5
About VFD Induced Shaft Voltages & Bearing Currents	6-12
Motor Grounding	13
AEGIS® Technology	14-17
AEGIS® Shaft Grounding Best Practices - Low Voltage	18-21
AEGIS® Shaft Grounding Best Practices - Medium Voltage	22-27
AEGIS® Shaft Grounding Best Practices - DC Motors	28-29
AEGIS® Installation and Shaft Preparation	30-33
AEGIS® Shaft Voltage Testing	34-43
Selecting the Correct Size Ring	44
AEGIS® Bearing Protection Ring Parts List	45-53
Engineering Specification	54
AEGIS® 2-Year Extended Warranty Description	55



Use of the EASA logo expresses membership only and not endorsement by EASA of the content in this handbook.



BEARING CURRENTS

MOTOR GROUNDING

AEGIS® TECHNOLOGY

LOW VOLTAGE MOTORS

MED VOLTAGE MOTORS

DC MOTORS

INSTALL SHAFT PREP

SHAFT VOLTAGE TESTING

SELECT CORRECT SIZE

PARTS LIST

ENGINEERING SPEC



**ANSI/EASA Standard AR100-2015, Section 2, Mechanical Repair: 2.2 Bearings**  
*“Bearings should be inspected for failure modes such as spalling, contamination, fretting, fluting, and scoring.”*

### Operation of Electrical Motors by Variable Frequency Drives:

AC Motors operated by variable frequency drives (VFD) use pulse width modulation (PWM) to control the speed of the motor. This means that there are common mode voltages which are capacitively induced onto the shaft of the motor and can discharge in the motor's bearings causing electrical discharge machining (EDM) pitting, frosting and fluting damage which results in unplanned downtime and repair costs. In addition, larger motors over 100 HP (75 kW) and medium voltage motors may also have high frequency circulating currents which can also cause EDM pitting, frosting and fluting damage. DC Motors on drives may also have capacitively induced shaft voltage which can discharge in the motor's bearings and in addition, motors over 10 HP (7.5 kW) may also have circulating currents.

### Bearing Protection Specified for New Motors and Motor Repair:

It is essential that motors operated by VFDs or DC drives are configured for bearing protection from both types of current sources. Installing AEGIS® Shaft Grounding Rings provide a proven and reliable ground path to discharge the capacitively induced voltages safely away from the motor's bearings to ground. Motors with circulating currents should also have shaft or housing insulation or one insulated bearing installed on opposite end from the AEGIS® Shaft Grounding Ring to stop the high frequency circulating current path. This approach is the recommended best practice to make inverter driven motors “True Inverter Duty” by protecting the most critical mechanical component of the motor – the motor's bearings.

### Bearing Inspection:

Whenever a VFD driven motor fails, the motor's bearings should be removed, cut, and inspected for evidence of EDM discharges. Sometimes it is obvious because the damage is visibly apparent with a “washboard” fluting pattern on the inner or outer bearing race. The ANSI/EASA AR100-2015 recommends this practice for all electric motor repairs. Preventing this failure mode from the start creates a common sense methodology for increasing the reliability of all VFD driven motor systems.

### Shaft Voltage Testing:

The NEMA MG1 Part 31.4.4.3 identifies capacitive shaft voltages of 10 to 40 volts peak (or 20 to 80 volts peak-to-peak) as a level which could cause electrical discharges in a motor's bearings. Testing for shaft voltages is the best way to confirm the need for AEGIS® Shaft Grounding Rings on VFD driven electric motors to prevent EDM bearing damage and to ensure uptime and reliability. The AEGIS® Shaft Voltage Tester™ Digital Oscilloscope is specifically designed to measure and record shaft voltages.

Shaft voltage testing is best accomplished as early as possible in the operation cycle of the VFD/Motor system and whenever a new motor is installed, after a motor repair or bearing replacement is done, and upon commissioning of newly constructed buildings or installation of new production equipment.

### Proper Earth Grounding of VFD-Driven Motor Systems:

Proper high-frequency (HF) grounding of VFD-driven motor systems is vital to prevent earth-level discontinuities between system components. It is especially critical in applications involving a motor and coupled equipment that are not mounted to a common baseplate. In such cases, effective HF grounding of all system components is necessary to equalize the electric potential between equipment frames and to prevent ground loops between the motor and coupled equipment. Widely recognized as the most efficient path to ground for high frequency currents, high-frequency grounding straps (such as AEGIS® HFGS) are recommended by major motor and drive manufacturers.



Patented Technology



## EDM Electrical Discharge Machining

Because of the high-speed switching frequencies in Pulse Width Modulation (PWM) inverters, variable frequency drives induce capacitively coupled shaft voltages in the electric motors they control. The high frequency switching speed of insulated-gate bipolar transistors (IGBT) used in these drives produce common mode voltages on the motor's shaft during normal operation through parasitic capacitance between the stator and rotor. These voltages, which can register 10-40 volts peak, are easily measured by touching an AEGIS® Shaft Voltage Probe™ to the motors shaft while the motor is running. The AEGIS-OSC-9100 Shaft Voltage Tester™, a 100 MHz Digital Oscilloscope, allows the voltages to be viewed and recorded for analysis.

Reference: NEMA MG1 Section 31.4.4.3

Once these voltages reach a level sufficient to overcome the dielectric properties of the bearing grease, they arc through the path of least resistance to the motor's housing. During virtually every VFD switching cycle, induced shaft voltage discharges from the motor's shaft to the frame via the bearings, leaving a small fusion crater (fret) in the bearing race. When this event happens, temperatures are hot enough to melt the 52100 vacuum degassed bearing steel and severely damage or burn the bearing lubrication.

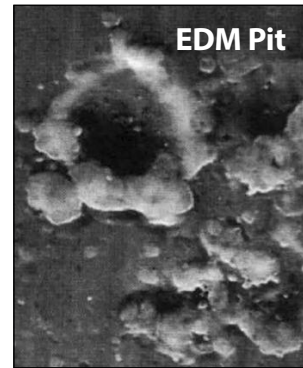
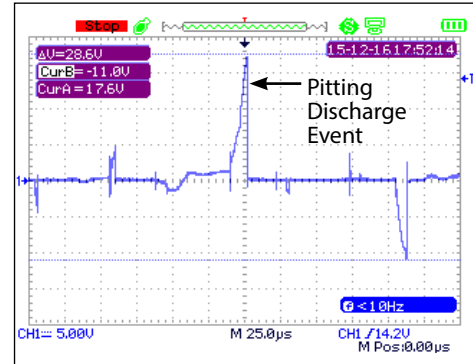
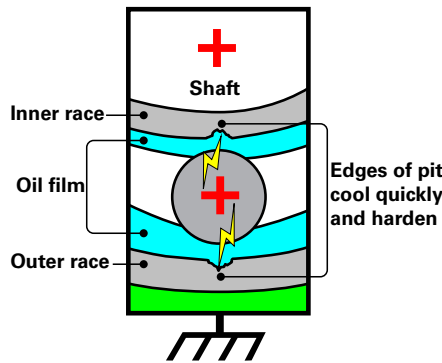

These discharges are so frequent (potentially millions per hour) that before long the entire bearing race surface becomes damaged with countless pits known as frosting. A phenomenon known as fluting may occur as well, producing washboard-like ridges across the frosted bearing race. Fluting causes audible noise and vibration and is an indication of a catastrophic failure mode. Regardless of the type of rolling element or raceway damage that occurs, the resulting motor failure often costs thousands of dollars in downtime and equipment failure related repair or replacement costs.

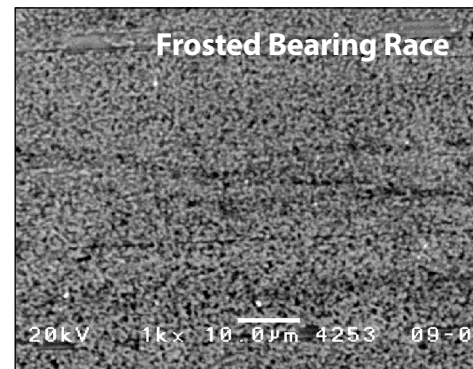

Failure rates vary widely depending on many factors, but evidence suggests that a significant portion of failures occur in only 3 to 12 months after system startup. All AC and DC motors operated by electronic drives or inverters have the potential of developing this failure in their bearings regardless of motor frame size or horsepower.

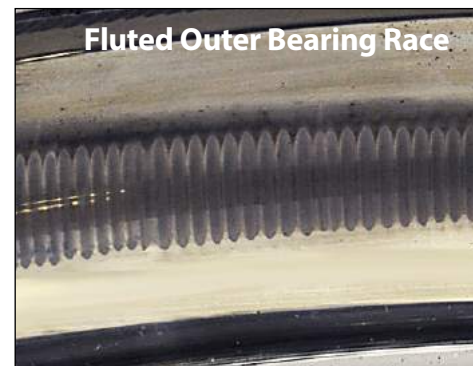

## Bearing Inspection



Cutting and inspecting every bearing in motors that come in for repair, especially motors operated on variable frequency drives, will often provide vital information to make the best repair recommendation and thus improve the machine's overall lifetime performance.

Report template available at: [www.est-aegis.com/bearing](http://www.est-aegis.com/bearing)



1. **Inspect the outside and the inside of both bearings** and retain a sample of the lubricant for analysis. Look for:
  - a. Contamination
  - b. Signs of excessive heat
  - c. Hardening of grease
  - d. Abnormal coloration (blackened grease)
  - e. Excess grease and oil escaping the bearing



2. **Cut the outer race** into halves. Remove seals or shields prior to cutting.



Follow established safety precautions and use personal protective equipment including eye protection, hearing protection, face shield, gloves and protective clothing.



3. **Inspect the grease** and any contamination in the bearing.
  - a. **Burnt Grease:** Continuous electrical arcing in the motor bearings will often rapidly deteriorate the lubricating capability of the grease and cause bearing race damage. When an arc occurs, the oil component of the grease is heated beyond its temperature capacity.
  - b. **Contamination:** In addition to the burnt grease, the arcing causes small metal particles to loosen from the bearing races/balls which are distributed in the grease. These particles are abrasive and will cause the bearing to prematurely wear.



Burnt bearing grease is blackened and oftentimes contaminated with metal particles.

New bearing grease is available in many colors. Blue grease (as shown) is Polyrex EM. It is commonly found in electric motor bearings.



**4. Clean the bearing's** components using a degreaser or solvent.

 Follow all safety precautions.

**5. Inspect for evidence of Electrical Discharge Machining (EDM):**

EDM damage is millions of microscopic electrical pits that are created when current discharges through the motor's bearings. The electrical voltage overcomes the dielectric of the bearing lubrication and instantaneously arcs through the inner race, through the rolling elements and to the outer race. The individual pits are usually between 5 and 10 micron diameter.



**6. Frosting:** This will appear to be a grey discolored line around all or part of the bearing race and may be evident in both the inner and outer race. The discoloration may be caused by mechanical wear or by EDM. Examination under a microscope may be required to determine if the line is EDM or of a mechanical nature. If the motor was operated on a VFD with no bearing protection there is a high likelihood that the frosting is from EDM.

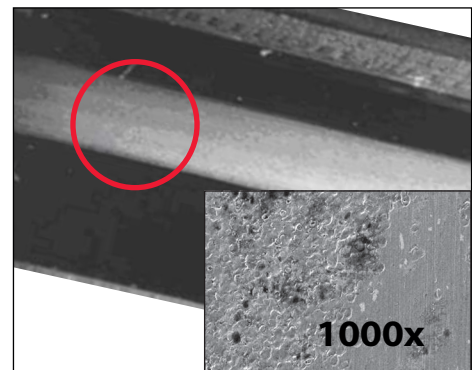

**7. Fluting Damage:** Identified by a distinctive washboard pattern. Fluting can be identified with the naked eye or with 10x magnification. Fluting is sometimes confused with mechanical bearing damage such as brinelling/false brinelling, so care should be taken to correctly assign electrical fluting damage to the pattern observed.

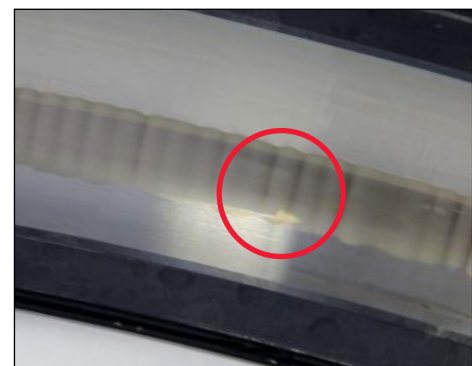

 In addition to using this manual, please refer to other bearing failure analysis experts in order to determine the root cause of failure.

Install new AEGIS® Ring whenever bearings are replaced on an inverter-driven motor.





## Three Sources of Bearing Current:

There are three sources of bearing currents discussed in this handbook, two of which, Capacitive EDM Current and High Frequency Circulating Current are sourced by the VFD. The third type, which we label 50/60Hz Circulating Current, is mainly in large AC motors that are operated by line voltages at 50/60 Hz.

1. **Capacitive EDM Current (from VFD):** Capacitive induced voltage from the pulse width switching waveform produced by the variable frequency drive (VFD). This voltage is coupled to the motor's shaft through parasitic capacitance and can discharge in the motor's bearings or in the bearings of attached equipment causing electrical discharge machining (EDM).
2. **High Frequency Circulating Current (from VFD):** High frequency circulating currents may flow due to a high-frequency flux produced by common-mode currents. High frequency inductive circulating currents from VFDs are in the kHz or MHz range and may be present in motors over 100 HP/75 kW. Generally the larger the motor the greater the effects of the high frequency circulating currents.
3. **50/60Hz Circulating Current (from line voltage):** 50/60 Hz Sine wave voltage sources in large machines can cause *extremely low frequency circulating currents* because of the motor's asymmetrical design and magnetic asymmetries.

### Total Qualitative Bearing Currents

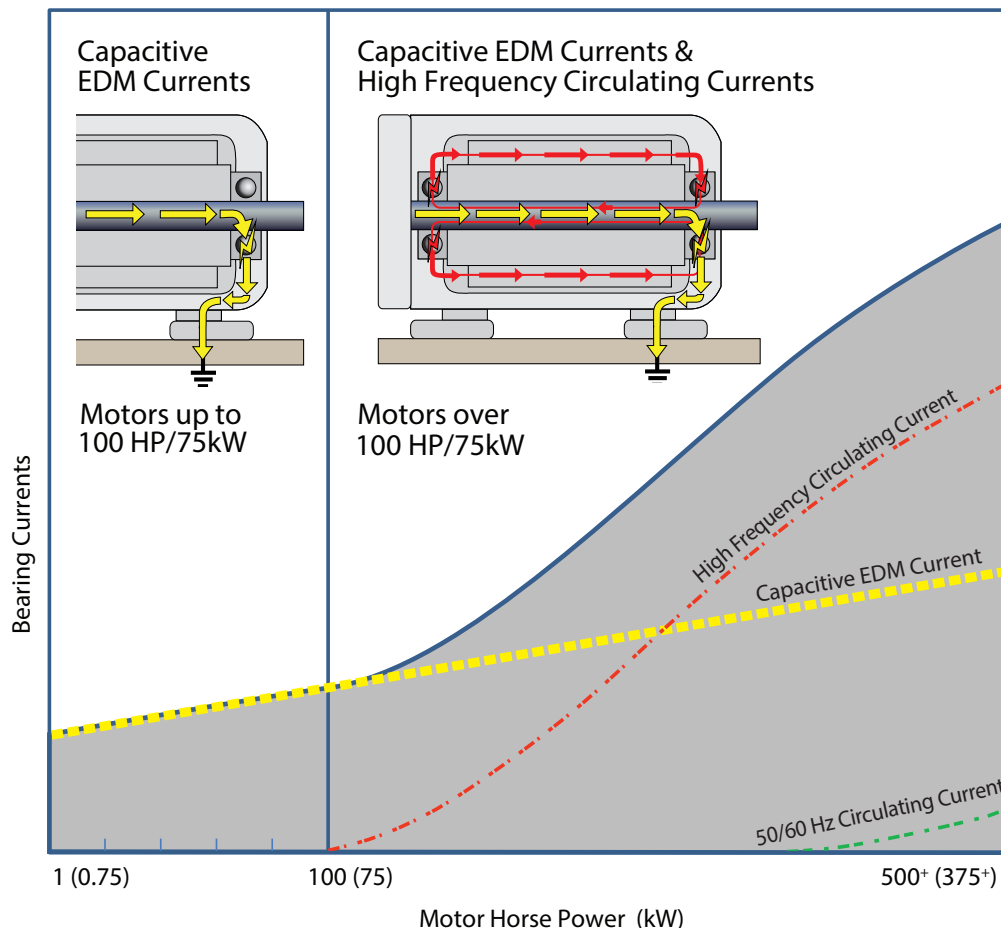

Patented Technology



## Electric Motors Operating on Line Voltage

Balanced voltage condition

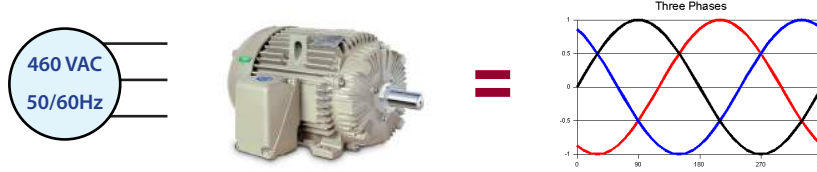

- Electric induction motors are designed for operation on 3 phase sine wave power - either 50 or 60 Hz.
- The input power is balanced in frequency, phase (120 degree phase shift) and in amplitude.
- Common mode voltage - the sum of the 3 phases always equal zero volts when properly balanced.

Note: Bearing protection generally not needed except for large frame motors.

## Electric Motors Operated by Variable Frequency Drives (VFD)

Unbalanced voltage condition

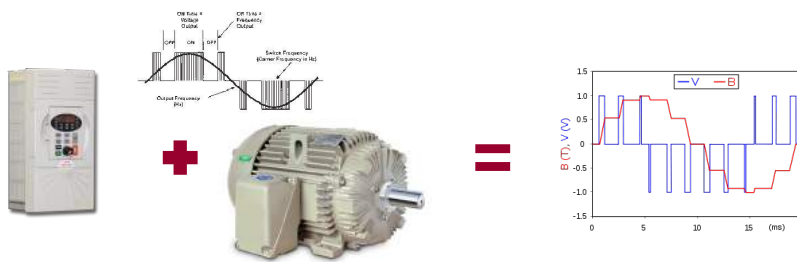

- When operated by VFD, the power to the motor is a series of positive and negative pulses instead of a smooth sine wave.
- The input voltage is never balanced because the voltage is either 0 volts, positive, or negative with rapid switching between pulses in all three phases.
- The common mode voltage is usually a "square wave" or "6 step" voltage wave form.

**!** Bearing protection needed to mitigate electrical discharge machining (EDM) damage in bearings.



## Capacitive EDM Current

### An Electric Motor works like a Capacitor

- The pulses to the motor from the VFD create a capacitively coupled common mode voltage on the motor's shaft.
- Creates electrical bearing discharge currents.
- Voltages are measurable with an AEGIS® Shaft Voltage Tester™ Digital Oscilloscope (AEGIS-OSC-9100) and AEGIS® SVP Shaft Voltage Probe™ Tip.

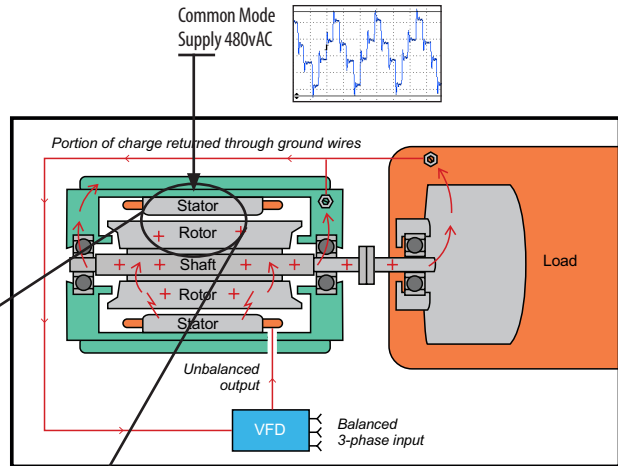
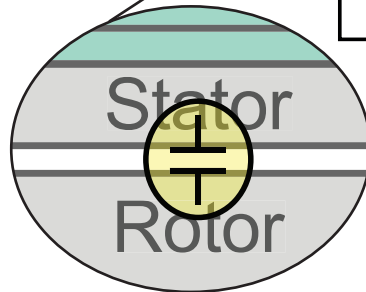

### Voltage Arcs through the Bearing

- Voltages arc through the bearings, and electrical discharge machining (EDM) creates thousands of pits in the bearing's race.
- Bearings degrade, resulting in increased friction and noise
- Eventually, the rolling elements can cause fluting damage to the bearing races
- Bearing lubrication/grease deteriorates, is burnt and fails
- Potential for costly unplanned downtime

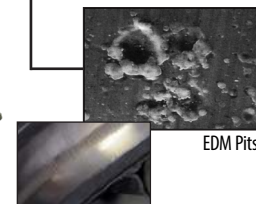
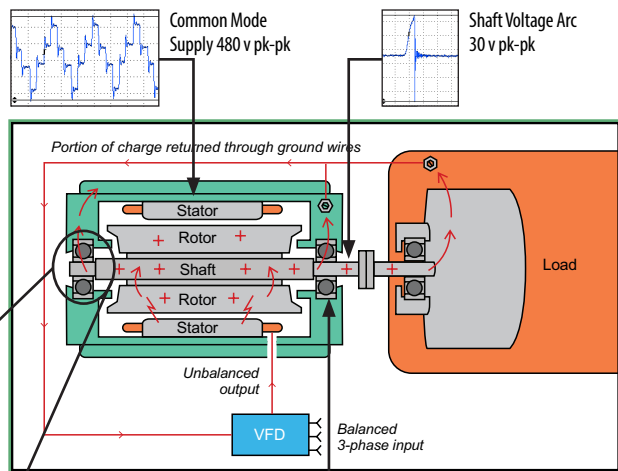
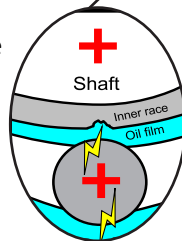

## High Frequency Circulating Currents on VFD Driven Motors

Induced by the magnetic flux imbalance around the motor shaft from the stator windings, these currents circulate through the motor bearings. High frequency circulating currents can be a problem in large AC motors over 100 HP (75 kW) and DC motors over 10 HP (7.5 kW).

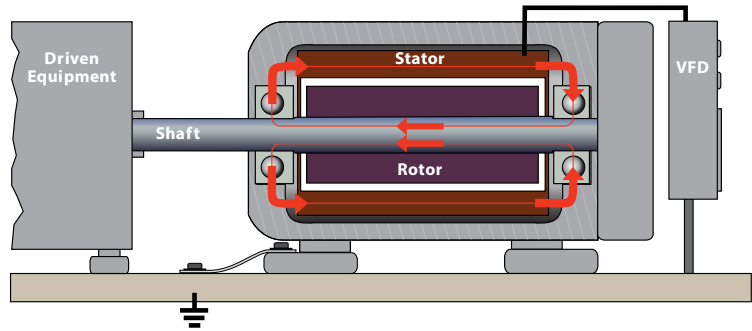

Along with the high frequency circulating currents you will also have the capacitive EDM current which can travel down the shaft to attached equipment and cause electrical discharge machining (EDM) in the equipment's bearings or gearing. Therefore it is important when considering high frequency circulating currents to also mitigate capacitive EDM current with the AEGIS® Shaft Grounding Ring to divert the voltages away from the drive end motor bearing and/or the attached equipment to ground.

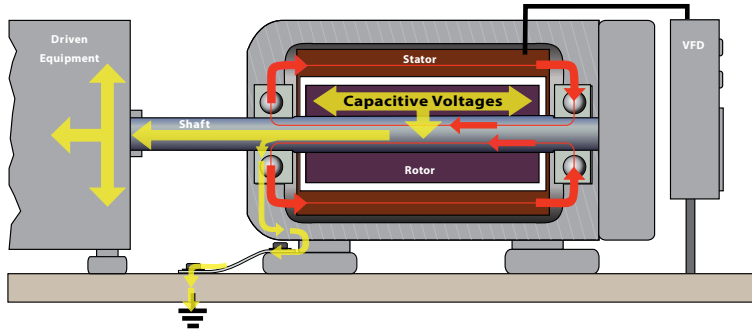

### Best Practice to Protect from Both Capacitive EDM Current and High Frequency Circulating Current

The recommended best practice is to stop the high frequency circulating currents by isolating or insulating the non-drive end of the motor (NDE) and to install an AEGIS® Shaft Grounding Ring on the drive end (DE), on the opposite side from the insulation, for capacitive EDM current. This practice will protect both the motor's DE bearing and the attached equipment.

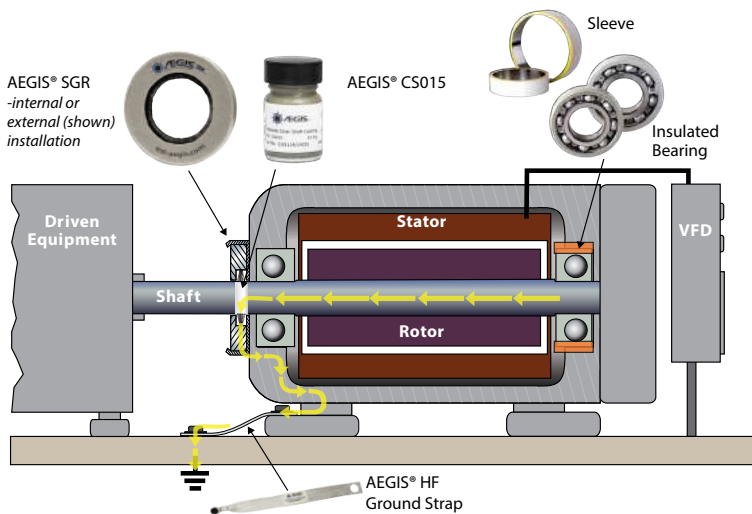

## 50/60 Hz Circulating Current - Low Frequency Circulating Currents from 50/60Hz Line Voltage in Motors over 500 Frame

Sinusoidal voltage sources can cause low frequency circulating currents in large machines due to the motor's asymmetrical design. 50/60Hz operation can result in circulating currents due to motor magnetic asymmetries.

- Usually present in very large machines only.
- Circulate through the motor bearings, shaft to frame.

**Best Practice:** Interrupting the circulating current is the best approach to mitigating potential bearing damage.

Ref: NEMA MG1 Part 31.4.4.3

Total Qualitative Bearing Currents

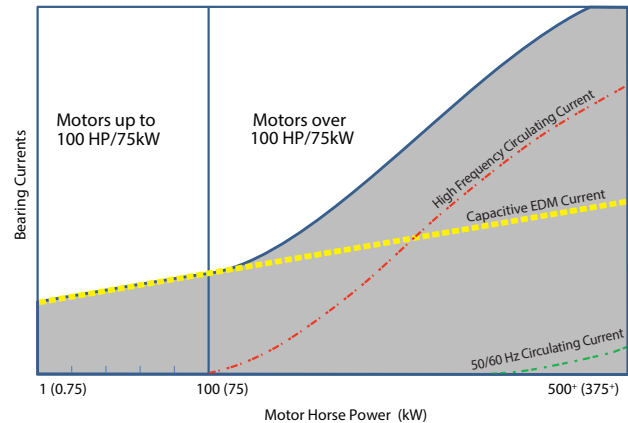

## Grounding Path

The AEGIS® Ring conducts harmful shaft voltages away from the bearings to ground. Voltage travels from the shaft, through the conductive microfibers, through the housing of the ring, through the hardware (or conductive epoxy) used to attach the ring to the motor, to ground.

The AEGIS® HFGS (High-Frequency Ground Strap) is a braided cable used to lower the impedance between the motor's frame and earth ground. Secure one end to motor and the other end to earth ground.

All paths must be conductive. When rebuilding a motor, overspray on the end bracket must be removed to ensure a conductive path to ground. Clean all fits. Use an Ohm meter to check resistance.

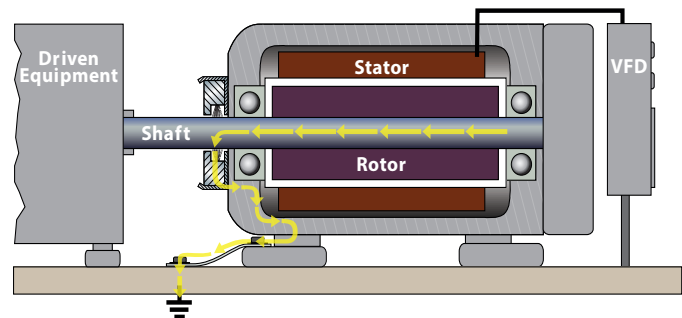



# AEGIS® High-Frequency Ground Strap Ensures Reliable Bond Between Motor Frame and System Ground

The AEGIS® Ring protects the motors bearings and prevents fluting and bearing failure and the High-Frequency Ground Strap (HFGS) ensures the reliable path to system ground.

Proper high-frequency (HF) grounding of VFD-driven motor systems is vital to prevent earth-level discontinuities between system components. It is especially critical in applications involving a motor and coupled equipment that are not mounted to a common baseplate. In such cases, effective HF grounding of all system components is necessary to equalize the potential between equipment frames and to prevent ground loops between the motor and coupled equipment.

Widely recognized as the most efficient path to ground for high frequency currents, grounding straps are recommended by major motor and drive manufacturers. AEGIS® High-Frequency Ground Straps ensure a very-low impedance path to ground from the frame of the motor for the high-frequency currents generated by VFD. Used in conjunction with AEGIS® Rings, which provide a safe path for damaging VFD-induced currents away from the motor's bearings to the motor's frame, AEGIS® HFGS bonding straps complete the path from motor's frame to system ground.

High-Frequency Ground Straps are designed with a tinned hole on one end (size based on NEMA/IEC frame) and a ring terminal on the opposite end to fit a 5/16" [8mm] screw. Standard lengths are available in 12" [305mm] and 24" [610mm] increments. Also available is a universal strap which includes a ring terminal on both ends. Longer straps and other terminations are available upon request. See page 53 for parts list.

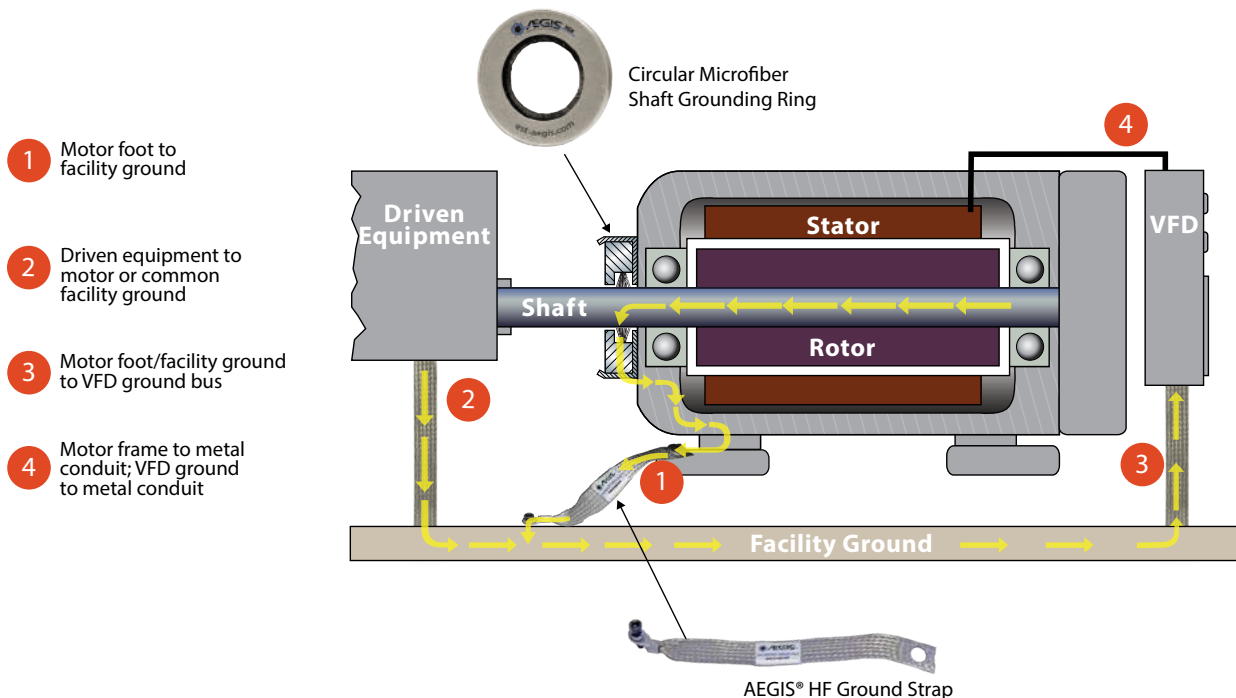

## AEGIS® Shaft Grounding Rings Provide Both Contact and Noncontact Grounding The Only Product of its Kind



**AEGIS® Shaft Grounding Ring uses Revolutionary Nanogap Technology**

- Unique contact/non-contact design
- 360 degrees circumferential conductive microfiber ring
- Multiple row design – greatest reliability
- Ensures unmatched shaft grounding and performance



The AEGIS® Shaft Grounding Ring's patented Nanogap Technology ensures effective electrical contact even when physical contact is broken. Only AEGIS® Nanogap Technology provides both maintenance-free contact and noncontact bearing protection for the normal service life of the motor's bearings as well as the most reliable operation of any shaft grounding technology.

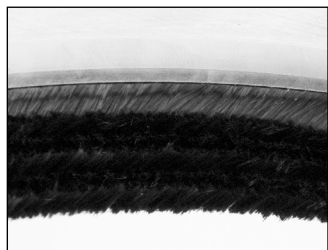

### Proprietary Conductive Microfibers Last for the Service Life of the Motor

The AEGIS® Shaft Grounding Ring's unique design features hundreds of thousands to millions of specially engineered conductive microfibers that encircle the motor shaft. With so many electrical transfer points the ring provides continuous electrical contact, whether its fibers are physically touching the shaft or not. This patented "nanogap" technology enables both contact and noncontact shaft grounding — 100% of the time.

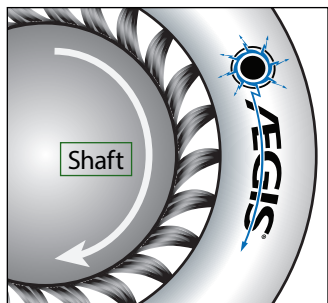

### Specially Designed Microfibers Flex Without Breaking

Designed with specific mechanical and electrical characteristics that minimize wear and maintain conductivity, AEGIS® microfibers will last for the life of the motor. Based on wear of less than 0.001" [0.025mm] during 10,000 hours of testing, proven to withstand over 200,000 hours of continuous operation.

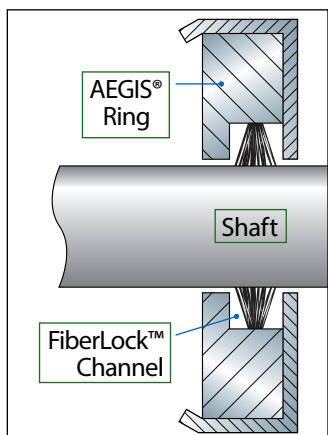

### Wear-to-Fit™ Design

Through our patented design, AEGIS® conductive microfibers are a wear-to-fit design which ensures that the fibers don't "wear out" during the bearing's life. They exhibit minimal wear with the ability to flex without breaking. During the life of the ring the minimal wear characteristics ensure that the fibers only wear to the exact diameter of the motor's shaft and no further, maintaining the nanogap contact which allows the AEGIS® Shaft Grounding Rings to continue to operate effectively and protect the motor's bearings. In testing, they were proven to withstand 2 million direction reversals (to 1800 RPM) with no fiber fatigue or breakage.

### Patented FiberLock™ Channel Secures and Protects Fibers

AEGIS's patented, protective FiberLock™ channel locks the ring's conductive microfibers securely in place around the motor shaft, allowing them to flex without breaking. The channel also helps protect the fibers from excessive dirt, oil, grease, and other contaminants.

In severe duty environments install the AEGIS® Rings inside the motors or add a protective O-ring or V-slinger against the AEGIS® Ring's face (see page 33). For large motors or medium voltage motors specify the AEGIS® PROSLR (page 23) which incorporates an O-ring barrier built into the shaft grounding ring to protect against dirt or debris.



Patented Technology

## Ensures Unmatched Grounding With or Without Shaft Contact

At any point in time, the AEGIS® microfibers are in mechanical contact with the shaft and those that aren't are in nanogap proximity due its unique design. Thanks to the patented Electron Transport Technology™, all of the ring's fibers remain in electrical contact with the motor shaft providing unmatched grounding 100% of the time. This technology ensures electrical contact for the life of the motor through mechanical contact and three simultaneous nanogap noncontact current transfer processes. These processes ensure effective grounding regardless of the motor's speed. No other product works with and without contacting the motor shaft to provide the long term and maintenance-free bearing protection of the AEGIS® Ring.

Tunneling of Electrons

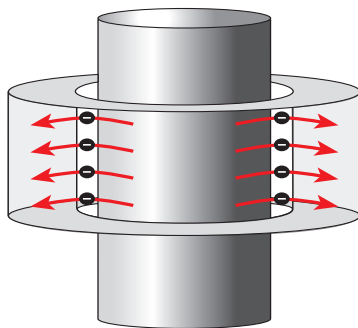

This mechanism is based on the ability of electrons to “tunnel” across an insulating barrier, and works for gaps smaller than 2 nm.

Field Emissions of Electrons

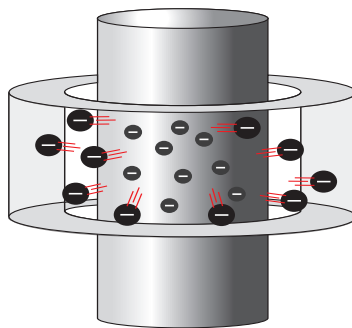

Field emission is a form of quantum tunneling whereby electrons move through a barrier in the presence of a high electric field. It provides grounding across gaps of 2 nm to 5 μm. The electric field from the shaft voltage creates the conditions for the AEGIS® ring fibers to take advantage of field emission electron transfer from the shaft.

Townsend Avalanche of Gaseous Ions

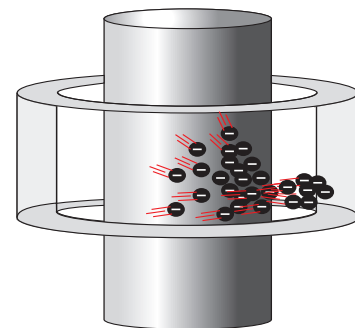

This process results from the cascading effect of secondary electrons released by collisions and the impact ionization of gas ions accelerating across gaps greater than 5 μm. This ionization creates negative and positive ions which neutralize the shaft voltage.

## AEGIS® Shaft Grounding Ring vs. Contact-Only Brush

The chart below compares the design and performance characteristics of AEGIS® Rings to those of conventional and discrete-point grounding brushes that work only through contact with the motor shaft. Due to its patented design and proprietary conductive microfibers, the AEGIS® Ring maintains electrical contact with the motor shaft even if mechanical contact is broken. No other shaft grounding brush provides such exceptional bearing protection.

Performance Characteristic	AEGIS® Ring	Contact-Only Brush
Continuous circumferential ring design	Yes	No
Contact and Noncontact electrical shaft grounding	Yes	No
Protective fiber channel	Yes	No
Ultra-low wear fibers / wear-to-fit fiber design	Yes	No
Maintenance-free	Yes	No
Effective in presence of dust, dirt, oil, and grease	Yes	No



## AEGIS® SGR for Low Voltage and AEGIS® PRO Series for Medium Voltage Motors

### LOW VOLTAGE MOTORS UP TO 500HP (375kW)

Supply voltage: 600 VAC or less  
 Recommended Technology: AEGIS® SGR

**!** Motors over 100 HP - recommend isolation of one bearing and AEGIS® SGR on the opposite bearing.



**Description:**

- Design Type: AEGIS® SGR
- Circumferential Conductive MicroFiber rows in FiberLock™ Channel
- Rows of fiber: 2
- Fiber overlaps shaft 0.030" [0.76mm]
- OAL: 0.295" [7.5mm]
- OD: listed in AEGIS® Parts List

**Mounting:**

- Internal or External
- Select based on shaft diameter
- Split and Solid versions available
- Custom brackets optional

### AEGIS® SGR Current Capability Chart

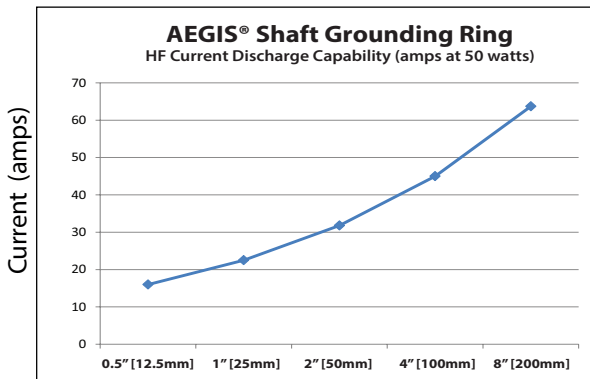

### MEDIUM VOLTAGE MOTORS AND LOW VOLTAGE MOTORS > 500HP (375kW)

Recommended Technology: AEGIS® PRO Series

**!** Recommend isolation of one bearing and AEGIS® PRO Series on the opposite bearing.



6 rows of Conductive MicroFiber

**Description:**

- Design Type: AEGIS® PRO Series
- Circumferential Conductive MicroFiber rows in FiberLock™ Channel
- Rows of fiber: 6
- Fiber overlaps shaft 0.030" [0.76mm]
- Varies by PRO Ring style
- OD: Shaft + (refer to drawing)

**Mounting:**

- Internal or External
- Select based on shaft diameter
- Split and Solid versions available
- Custom brackets optional

### AEGIS® PRO Series Current Capability Chart

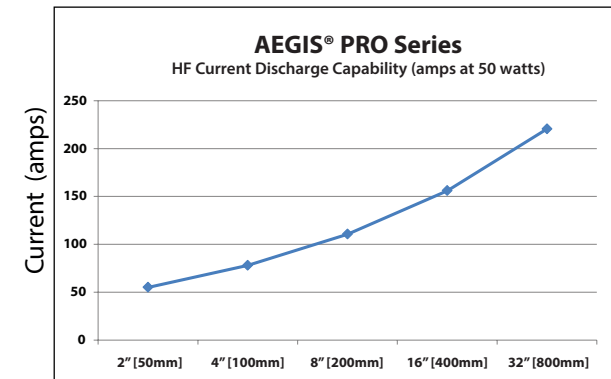

Patented Technology





## Manufacturer's Specification

Fiber Flexibility	AEGIS® Rings are constructed with patented AEGIS® FiberLock™ channel to allow conductive micro fibers to bend and flex within their elastic design limits. Multiple rows of fiber are distributed 360 degrees inside the FiberLock™ channel to provide maximum shaft surface contact. Fiber length is designed with an optimal shaft overlap.
Fiber wear	Usually less than 0.001" [0.03mm] in 10,000 hours. Fiber wear length is designed for expected life of 200,000+ hours based on testing. Wear rate may vary depending on conditions in individual applications. Fibers retain contact/noncontact function.
Friction	Little or no frictional axial or radial fiber pressure applied to shaft. Extremely light contact only. Designed for minimal friction with no reduction in motor performance.
Shaft Surface Finish	Ra 130 micro-inch finish or better.
AEGIS® Shaft Grounding Ring Maintenance Requirements	The AEGIS® Ring does not require maintenance. The shaft must remain conductive for shaft current discharge.
Replacement	Install new AEGIS® Ring whenever bearings are replaced on inverter-driven motors.
Oil and Grease on Motor Shaft	Small amounts of oil and/or grease are acceptable if the shaft surface remains conductive. Fibers are designed to maintain contact with the motor shaft and "sweep" oil away from surface.
Dirt/dust	Small amounts of dust and/or small particles are acceptable. Fibers "sweep" particles from shaft surface during operation. Shaft surface must remain conductive.
Directional rotation	Motor may be operated in clockwise or counter clockwise rotation. Motor may change directional rotation without limitations.
Eccentricity	0.010" [0.25mm] Total Indicator Runout in area where AEGIS® Ring is installed.
Maximum surface rate/RPM	No Maximum rating - There is no theoretical RPM limit as there is virtually no frictional contact with the shaft at high RPM. Verify specific applications with AEGIS® engineering.
Maximum temperature rating	410°F (210°C) - Verify application specific temperatures with AEGIS® engineering.
Minimum temperature rating	-112°F (-80°C) - Verify application specific temperatures with AEGIS® engineering.
Humidity	0 to 90% - Verify application specific acceptable humidity with AEGIS® engineering
Surface Conductivity	Coating the shaft with AEGIS® Colloidal Silver Shaft Coating (CS015) will enhance surface conductivity and help prevent rust/corrosion.
RoHS Test Results  Directive 2002/95/EC for the Restriction of the use of certain Hazardous Substances in electrical and electronic equipment applies	<p>All materials used in manufacture of AEGIS® Rings are in compliance with Directive 2002/95/EC, Restriction of the use of certain Hazardous Substances in electrical and electronic equipment. No RoHS banned substances are present in excess of the maximum concentration values (MCV).</p> <ol style="list-style-type: none"> <li>Following substances were found to be less than 0.1% by weight in homogeneous materials (required by RoHS directive):                      Lead (Pb)                      Mercury (Hg)                      Hexavalent chromium (Cr(VI))                      Polybrominated biphenyl (PBB)                      Polybrominated diphenyl ether (PDPE)</li> <li>Following substance is less than 0.01% by weight in homogeneous materials (required by RoHS directive):                      Cadmium (Cd)</li> </ol> <p>Note: Request RoHS Certification Letter from sales@est-aegis.com or call 1-866-738-1857</p>
Hazardous areas	Not certified for external mounting in hazardous environments (Class 1 Division 1, Division 2 or Class 1 Zone 1, Zone 2). AEGIS® Shaft Grounding Rings may be installed inside an Explosion Proof enclosure per IEEE Std 303™-2004 or inside an XP motor.
CE and UL requirements	AEGIS® Rings are classified as a "component" and as such are not subject to the requirements of any Directive. The application of CE or UL Mark is not applicable to this component.

## AEGIS® Shaft Grounding Best Practices-Low Voltage Motors

## Motors up to and including 100 HP (75 kW)

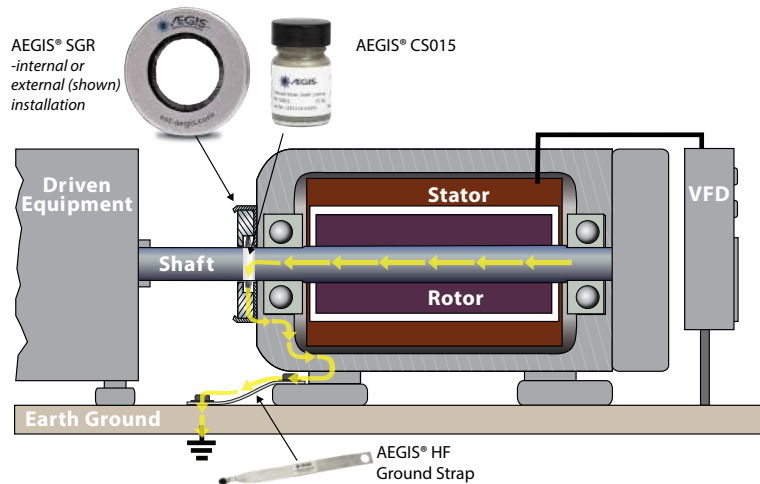

Protects motor bearings and bearings in attached equipment.

## Low Voltage Motors:

General recommendations: For induction motors operated on PWM IGBT VFD's either foot mounted, C-face or D-flange mounted motors with single row radial ball bearings on both ends of the motor. Motors may be installed either horizontally or vertically in the customer's application.

- Install one AEGIS® SGR Bearing Protection Ring on either the drive end or the non-drive end of the motor to discharge capacitive induced shaft voltage.
- AEGIS® SGR may be installed either internally or externally.
- Use AEGIS® Colloidal Silver Shaft Coating (PN# CS015) on motor shaft where fibers touch.

**!** Product recommendation: AEGIS® SGR

**!** Follow all safety precautions. GHS SDS available for download at [www.est-aegis.com](http://www.est-aegis.com)

## Motors Greater than 100 HP (75 kW)

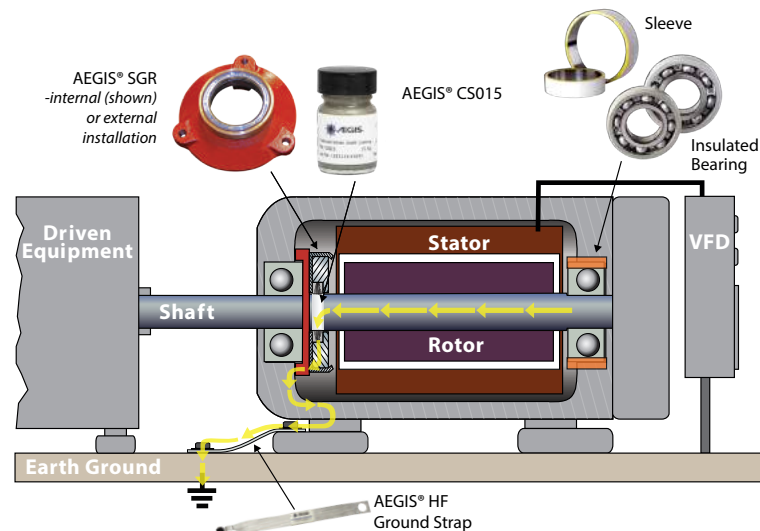

Install AEGIS® Ring on opposite end from insulation

## Low Voltage Motors:

For horizontally mounted motors with single row radial ball bearings on both ends of the motor:

- Non-Drive end: Bearing housing must be isolated with insulated sleeve or coating or use insulated ceramic or hybrid bearing to disrupt circulating currents.
- Drive end: Install one AEGIS® Shaft Grounding Ring.
- AEGIS® Ring can be installed internally on the back of the bearing cap or externally on the motor end bracket.
- Use AEGIS® Colloidal Silver Shaft Coating (PN# CS015) on motor shaft where fibers touch.

**!** Product recommendation:

- ♦ Low Voltage Motors up to 500HP: AEGIS® SGR
- ♦ Low Voltage Motors over 500HP: AEGIS® PRO Series

For Technical Support: [sales@est-aegis.com](mailto:sales@est-aegis.com) or call 1-866-738-1857



Patented Technology

## Motors Where Both Bearings are Insulated - Any HP/kW

### Low Voltage Motors:

- Install one AEGIS® Shaft Grounding Ring, drive end preferred, to protect bearings in attached equipment (gearbox, pump, fan bearing and encoder, etc...).
- AEGIS® Ring can be installed internally on the back of the bearing cap or externally on the motor end bracket.
- Colloidal Silver Shaft Coating PN CS015 is required for this type of application.



**Product recommendation:**

- ♦ Low Voltage Motors: **AEGIS® SGR**
- ♦ Low Voltage Motors over 500HP: **AEGIS®PRO Series**



Bearings in attached equipment may be at risk from VFD induced shaft voltage unless AEGIS® Shaft Grounding is installed.

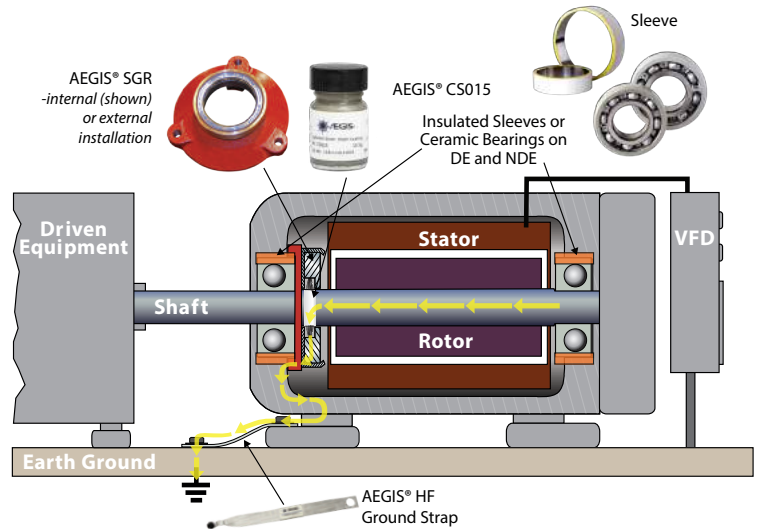

Install AEGIS® Ring on opposite end from insulation

## Motors with Cylindrical Roller, Babbitt or Sleeve Bearings

### Low Voltage Motors:

- Cylindrical Roller Bearing, Babbitt, or Sleeve bearing: Bearing housing should be isolated or use insulated bearing.
- Motors with insulated cylindrical roller bearing DE: Install AEGIS® Shaft Grounding Ring on opposite drive end (NDE).
- AEGIS® Ring can be installed internally on the back of the bearing cap or externally on the motor end bracket.
- Colloidal Silver Shaft Coating PN CS015 is required for this type of application.



**Product recommendation:**

- ♦ Low Voltage Motors: **AEGIS® SGR**
- ♦ Low Voltage Motors over 500HP: **AEGIS®PRO Series**

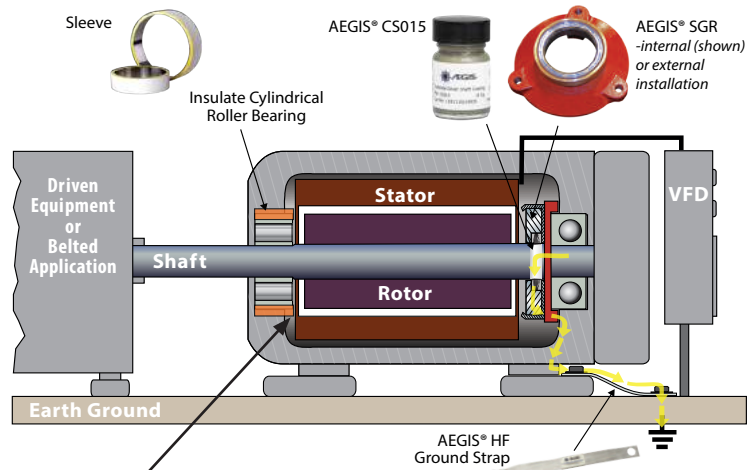

Note: Insulating the DE cylindrical roller bearing is preferred. However, if this is not possible, then insulate the NDE bearing instead and install an AEGIS® Ring on the DE (cylindrical roller bearing side).

AEGIS® Ring must be installed opposite side of insulation.



## AEGIS® Shaft Grounding Best Practices-Low Voltage Motors

### Vertical Solid Shaft Motors up to and including 100 HP (75 kW)

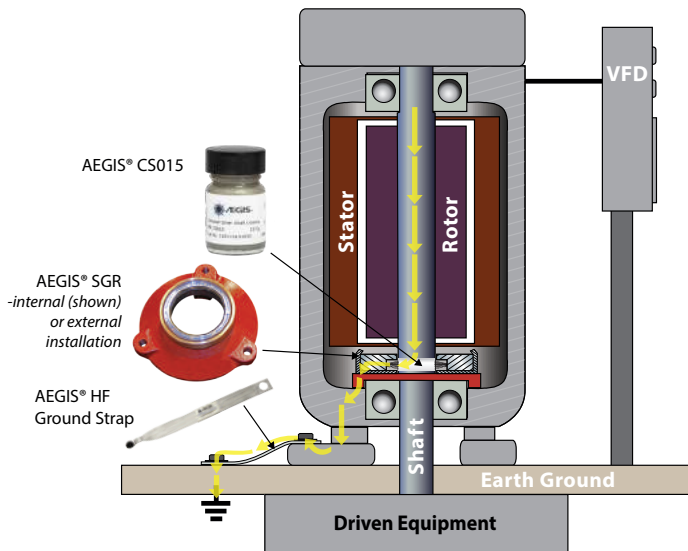

#### Low Voltage Motors:

- Lower Bearing: Install one AEGIS® SGR Bearing Protection Ring.
- AEGIS® SGR can be installed internally on the back of the bearing cap or externally on the motor end bracket.
- Colloidal Silver Shaft Coating PN CS015 is required for this type of application.

**!** Product recommendation: **AEGIS® SGR**

**!** Follow all safety precautions. MSDS available for download at [www.est-aegis.com](http://www.est-aegis.com)

### Vertical Solid Shaft Motors Greater than 100 HP (75 kW)

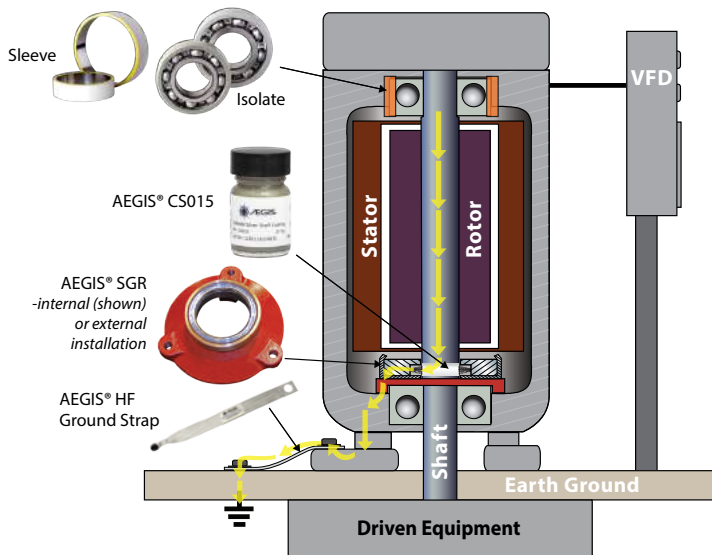

#### Low Voltage Motors:

- Upper Bearing: Bearing journal must be isolated or insulated ceramic or hybrid ceramic bearing installed.
- Bottom Bearing: Install one AEGIS® Shaft Grounding Ring.
- AEGIS® Ring can be installed internally on the back of the bearing cap or externally on the motor end bracket.
- Colloidal Silver Shaft Coating PN CS015 is required for this type of application.

**!** Product recommendation:  
 ♦ Low Voltage Motors: **AEGIS® SGR**  
 ♦ Low Voltage Motors over 500HP: **AEGIS®PRO Series**



Patented Technology



## Vertical (Hollow & Solid Shaft) Thrust Handling Motors up to and including 100 HP (75 kW)

### Low Voltage Motors:

- Lower Bearing: Install one AEGIS® SGR Bearing Protection Ring.
- AEGIS® SGR can be installed internally on the back of the bearing cap.
- Colloidal Silver Shaft Coating PN CS015 is required for this type of application.

**! Product recommendation: AEGIS® SGR**

Note: For external installation, the AEGIS® Ring must run on the motor or pump shaft at the lower bearing. Ring must not be mounted around the steady bushing.

Upper bearing may be isolated with insulated bearing carrier for added protection.

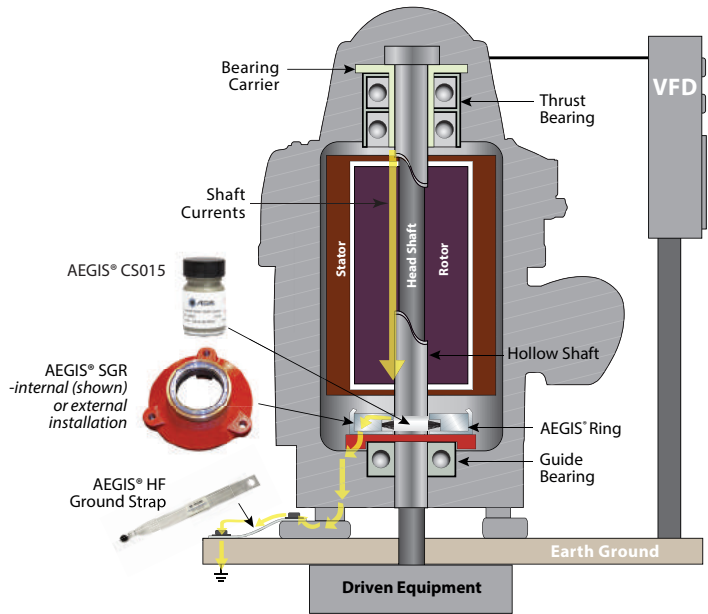

## Vertical (Hollow & Solid Shaft) Thrust Handling Motors Greater than 100 HP (75 kW)

### Low Voltage Motors:

- Upper Bearing: Bearing carrier must be isolated or insulated ceramic or hybrid ceramic bearing installed.
- Lower Bearing: Install one AEGIS® Shaft Grounding Ring.
- AEGIS® Ring can be installed internally on the back of the bearing cap.
- Colloidal Silver Shaft Coating PN CS015 is required for this type of application.

**! Product recommendation:**

- ♦ Low Voltage Motors: AEGIS® SGR
- ♦ Low Voltage Motors over 500HP: AEGIS® PRO Series

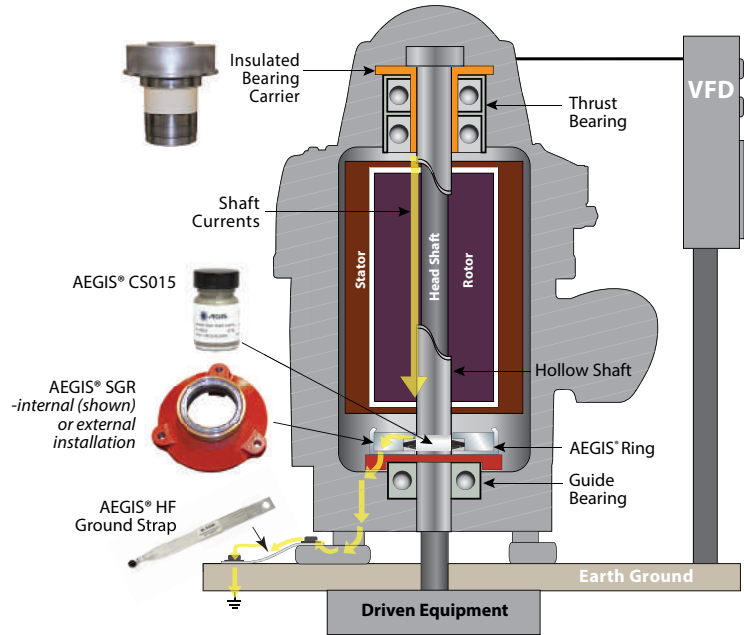

## AEGIS® Shaft Grounding Best Practices-Medium Voltage Motors

### AEGIS® PRO Series - Shaft Grounding Rings For Maximum Bearing Protection

The AEGIS® PRO Series design provides reliable shaft grounding for medium voltage applications, generators and turbines to divert harmful shaft voltages to ground and extend bearing life. Install the AEGIS® PRO on the DE and insulate the bearing on the opposite end (NDE) for best results. Large motors and generators often have much higher induced shaft voltages and bearing currents. The six circumferential rows of conductive microfiber provide the extra protection for these high current applications.

Generators may experience current surges which can cause electrical arcing in their bearings and equipment. The AEGIS® PRO Rings have a high current capable design and can discharge these currents.

Designed for:

- Large frame low-voltage motors: 500 HP (375kW) or greater
- Medium-voltage motors
- DC motors: 300 HP or greater

#### Specifications:

- Available in shaft diameters from 2.5" to 30" [63.5mm to 762mm]
- Circumferential Conductive MicroFiber rows in FiberLock™ Channel
- Rows of fiber: 6
- Fiber overlaps shaft 0.030" [0.76mm]
- Ships with CS015 AEGIS® Colloidal Silver Shaft Coating

#### Options:

- Solid and split ring designs
- Monitoring ring option for voltage monitoring
- Stock brackets and stand-off kits
- Custom brackets available

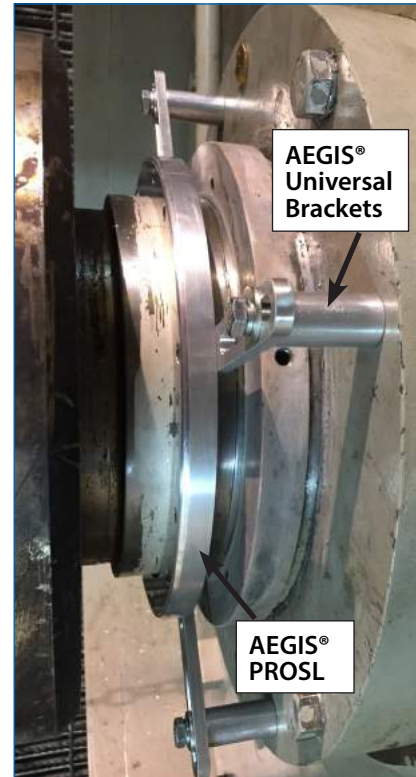

AEGIS® PROSL  
with Universal Brackets

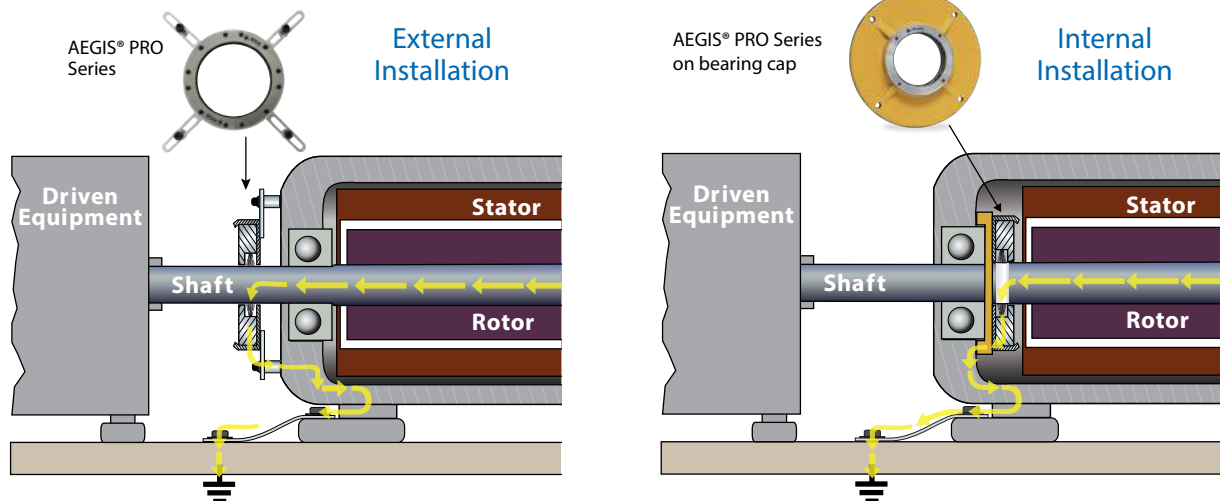

Patented Technology

## AEGIS® PRO Series - Shaft Grounding Ring

### AEGIS® PROSL

The AEGIS® PROSL is a high current capable AEGIS® PRO Series Bearing Protection Ring for large motors, generators and turbines operated by VFDs. The slim design and flexible installation options allow for adaptation to virtually all large motors.

Specifications

- Designs: Solid, Split and Press Fit
- Shaft Dia: 2.5" to 15.75" [63.5mm to 400mm]
- OD: Shaft Dia + 1.86" [47.24mm]
- OAL: 0.650" [16.51mm] MAX assembled with mounting screws
- Mounting: Supplied with screws for bolt through mounting
  - English: 8-32 x 1" Flat Head Cap Screws
  - Metric: M4 x .7 x 25mm Flat Head Cap Screws

*Optional Universal Brackets for easy mounting.*

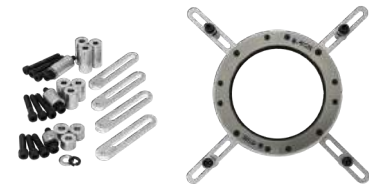

### AEGIS® PROSLR

Severe Duty motors are operated in general processing industry applications requiring protection from severe environmental operating conditions - often where there is debris, powder, dirt, liquids, lubricants or other contaminants. For these applications the AEGIS® PROSLR incorporates an O-ring dust and debris barrier which will prevent ingress of materials that could interfere with the contact of the conductive microfibers to the motor's shaft.

Note: When the AEGIS® PROSLR is installed inside the motor the O-ring barrier will prevent grease from clogging the fibers in an over-lubricated condition.

Specifications

- Designs: Solid and Split
- Shaft Dia: 2.5" to 15.75" [63.5mm to 400mm]
- OD: Shaft Dia + 1.86" [47.24mm]
- OAL: 0.775" [19.68mm] assembled with mounting screws
- Mounting: Supplied with screws for bolt through mounting
  - English: Solid Ring 8-32 x 1" FHCS, Split Ring 8-32 x 1.25" FHCS
  - Metric: Solid Ring M4 x .7 x 25mm FHCS, Split Ring M4 x .7 x 31mm FHCS

*Optional Universal Brackets for easy mounting.*



### AEGIS® PROMAX

The AEGIS® PROMAX is designed for installation on the most critical and largest motors, generators and turbines. Scalable to any shaft diameter over 15.75" [400mm], this high current capable AEGIS® PROMAX Shaft Grounding Ring is custom engineered for each application to ensure the best bearing protection possible.

Specifications

- Designs: Split Ring only
- Shaft Dia: 15.75" to 30" [400mm to 762mm]
- OD: Shaft Dia + 3.0" [76.2mm]
- OAL: 1.875" [47.62mm] assembled with mounting screws
- Mounting: Supplied with (4) M8 x 1.25 x 50 Socket Head Cap Screws for bolt through mounting

Custom brackets available upon request



## AEGIS® PRO Series Shaft Grounding Ring

### AEGIS® PROMR

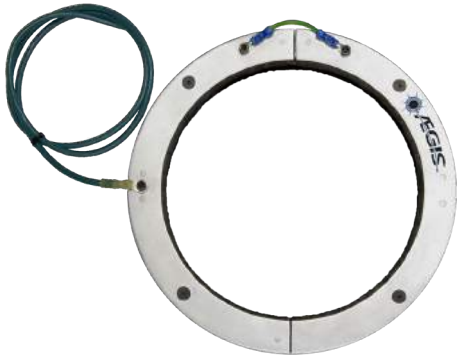

The AEGIS® PROMR “monitoring ring” combines the AEGIS® PROSL with an additional isolated SGR ring that can be used as a monitoring device. The PROSL channels the voltages and currents safely to ground while the monitoring SGR ring measures voltage on the shaft and is not grounded. A phenolic plate between the 2 rings is used to isolate the monitoring ring.

For shaft diameter of 2.5” to 15.75” [63.5mm to 400mm].

Designs: Solid and Split

OD: Shaft Dia + 1.86” [47.24mm]

OAL: 1.312” [33.32mm] assembled with mounting screws

Mounting: Supplied with screws for bolt through mounting

English Screws: 8-32 x 1” Flat Head Cap Screws

Metric Screws: M4 x .7 x 25mm Flat Head Cap Screws

*Optional Universal Brackets for easy mounting.*

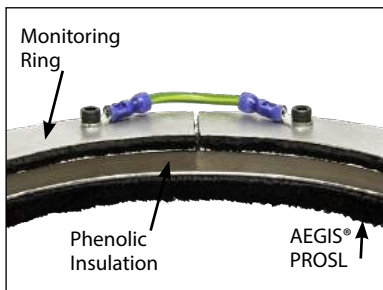

## Optional Mounting Brackets for AEGIS® PRO Series

For AEGIS® PROSL, PROSLR, PROMR



### AEGIS® PROSL Universal Brackets

Kit includes brackets, four different spacer lengths and hardware for each. See parts list for details (page 51).

## Custom Brackets/Installation Examples

Contact our Engineering Team for special mounting applications.



Custom Split Mounting Plate  
with tie bars



Bearing Cap Mounting



Custom Mounting Brackets



Patented Technology



## Motors Greater than 100 HP (75 kW)

### Medium Voltage Motors:

For horizontally mounted motors with single row radial ball bearings on both ends of the motor:

- Non-Drive end: Bearing housing must be isolated with insulated sleeve or coating or use insulated ceramic or hybrid bearing to disrupt circulating currents.
- Drive end: Install one AEGIS® Shaft Grounding Ring.
- AEGIS® Ring can be installed internally on the back of the bearing cap or externally on the motor end bracket.
- Use AEGIS® Colloidal Silver Shaft Coating (PN# CS015) on motor shaft where fibers touch.

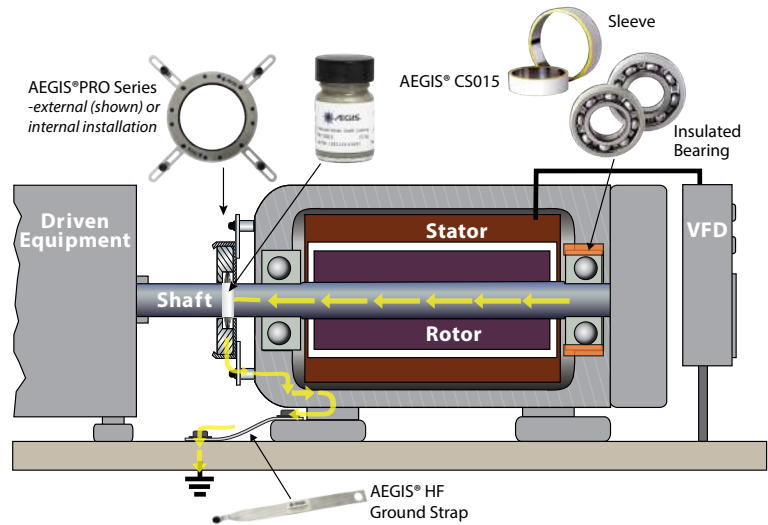

Install AEGIS® Ring on opposite end from insulation

**!** Product recommendation:  
AEGIS® PRO Series

## Motors Where Both Bearings are Insulated - Any HP/kW

### Medium Voltage Motors:

- Install one AEGIS® Shaft Grounding Ring, drive end preferred, to protect bearings in attached equipment (gearbox, pump, fan bearing and encoder, etc...).
- AEGIS® Ring can be installed internally on the back of the bearing cap or externally on the motor end bracket.
- Colloidal Silver Shaft Coating PN CS015 is required for this type of application.

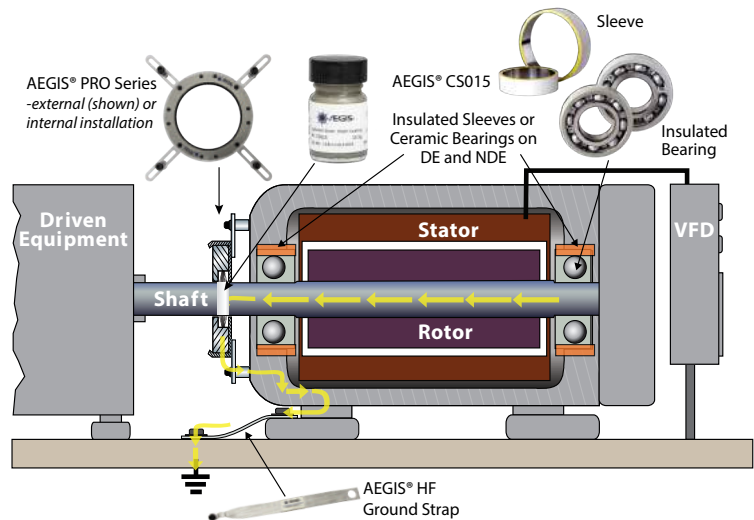

Install AEGIS® Ring on opposite end from insulation

**STOP** Bearings in attached equipment may be at risk from VFD induced shaft voltage unless AEGIS® Shaft Grounding is installed.

**!** Product recommendation:  
AEGIS® PRO Series





## AEGIS® Shaft Grounding Best Practices -Medium Voltage Motors

### Motors with Cylindrical Roller, Babbitt or Sleeve Bearings

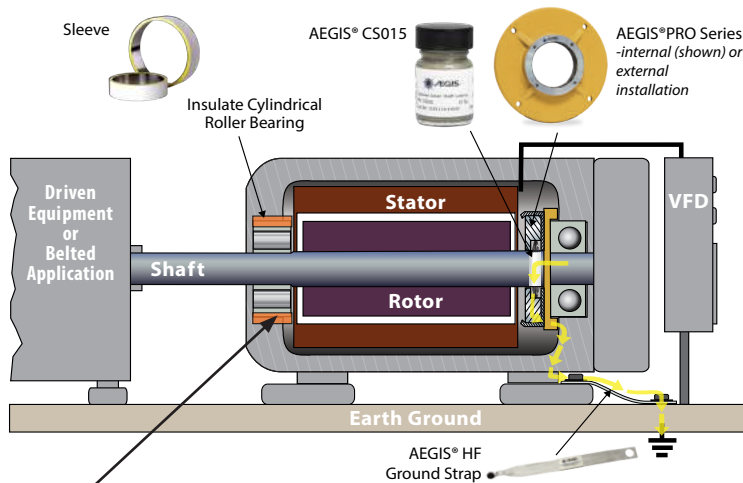

Note: Insulated DE bearing is preferred. However, if this is not possible then insulate the NDE bearing instead and install an AEGIS® Ring on the DE (cylindrical roller bearing side).

AEGIS® Ring must be installed opposite side of insulation.

#### Medium Voltage Motors:

- Cylindrical Roller Bearing, Babbitt, or Sleeve bearing: Bearing housing should be isolated or use insulated bearing.
- Motors with insulated cylindrical roller bearing DE: Install AEGIS® Shaft Grounding Ring on opposite drive end (NDE).
- AEGIS® Ring can be installed internally on the back of the bearing cap or externally on the motor end bracket.
- Colloidal Silver Shaft Coating PN CS015 is required for this type of application.



**Product recommendation:**  
**AEGIS® PRO Series**

### Vertical Solid Shaft Motors Greater than 100 HP (75 kW)

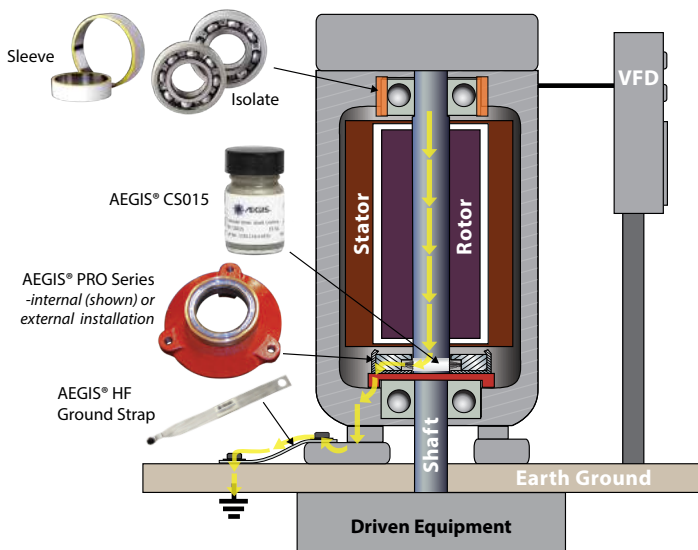

#### Medium Voltage Motors:

- Upper Bearing: Bearing journal must be isolated or insulated ceramic or hybrid ceramic bearing installed.
- Bottom Bearing: Install one AEGIS® Shaft Grounding Ring.
- AEGIS® Ring can be installed internally on the back of the bearing cap or externally on the motor end bracket.
- Colloidal Silver Shaft Coating PN CS015 is required for this type of application.



**Product recommendation:**  
**AEGIS® PRO Series**



Patented Technology

## Vertical Hollow Shaft Motors Greater than 100 HP (75 kW)

### Medium Voltage Motors:

- Upper Bearing: Bearing carrier must be isolated or insulated ceramic or hybrid ceramic bearing installed.
- Lower Bearing: Install one AEGIS® Shaft Grounding Ring.
- AEGIS® Ring can be installed internally on the back of the bearing cap.
- Colloidal Silver Shaft Coating PN CS015 is required for this type of application.

**! Product recommendation:**  
AEGIS® PRO Series

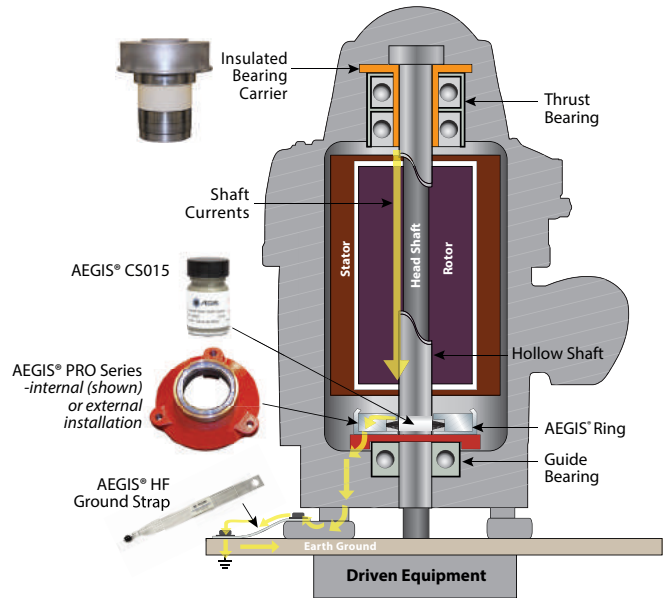

## All AEGIS® PRO Series Rings are custom-manufactured to the measurements provided

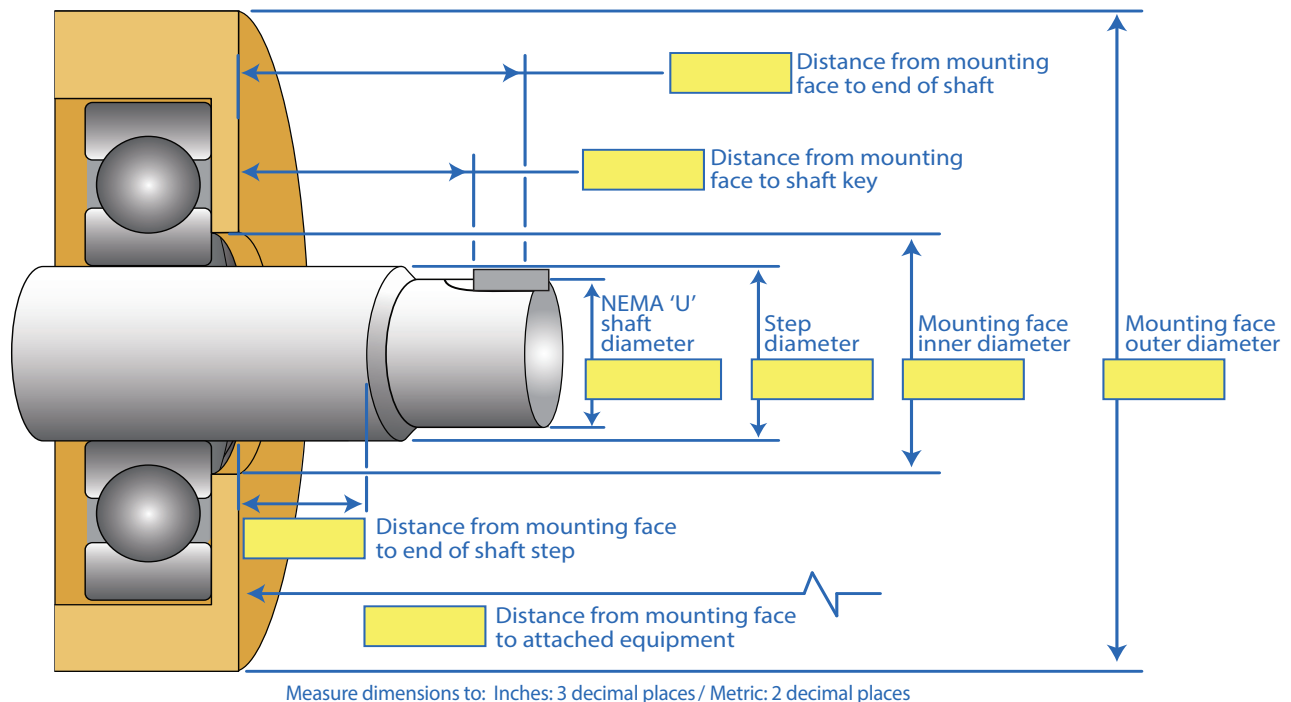

## AEGIS® Shaft Grounding for DC Motors

DC motors when operated on drives may also require bearing protection from induced shaft voltages. Capacitive induced shaft voltages may be hundreds of volts peak-to-peak and depending on the drive will increase in amplitude as the speed of the motor is increased. If there is no shaft grounding ring installed, the voltages may discharge through the bearings causing EDM pitting and fluting failure. In addition, circulating currents from magnetic dissymmetry may exist on DC motors over 10 HP (7.5 kW) <sup>(1)</sup>. This would necessitate the insulation of the NDE bearing, with an AEGIS® Shaft Grounding Ring installed on the opposite end of the motor.

(1) EASA web seminar: *Dealing with Shaft and Bearing Currents*, Thomas H. Bishop, P.E., Electrical Apparatus Service Association, January 19, 2011

Recommendation: Install AEGIS® SGR on the DE of the DC motor for all motors up to 300 HP (225 kW). For DC motors over 10 HP (7.5 kW), also insulate the NDE bearing.



## AEGIS® PRO Series Shaft Grounding Ring for Large DC Motors 300 HP (225 kW) and Greater

Large DC motors over 300 HP (225 kW) have higher shaft voltages and currents and require the AEGIS® PRO Series installed on the DE of the motor. In addition, the NDE bearing should have insulation to prevent circulating currents.



### DC Motor - Before and After Testing with AEGIS® Installed 350 HP DC Motor - DC Inverter Drive

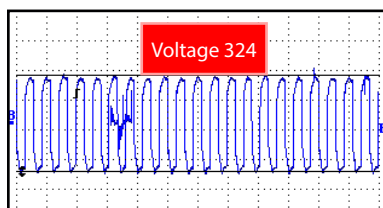

Capacitive induced shaft voltage before bearing current discharge through the bearings. Square wave from DC SCR drive.

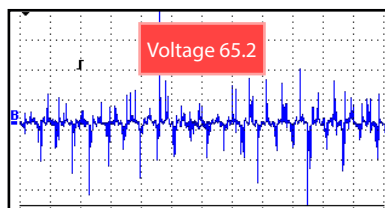

**No Shaft Grounding**  
Volts: 65.2 V pk-pk  
Bearing discharges (EDM)

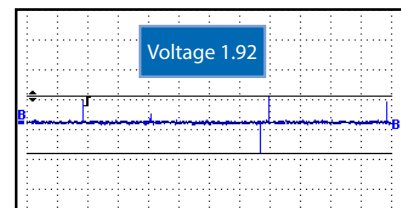

**AEGIS® Shaft Grounding**  
Volts: 1.92 V pk-pk  
Discharge through AEGIS® Shaft Grounding Ring



## DC Motors up to and including 10 HP (7.5 kW) - Operated on DC Inverter<sup>(1)</sup>

### DC Motors:

- Install one AEGIS® SGR Bearing Protection Ring on either the drive end or the non-drive end of the motor to discharge induced shaft voltage.
- AEGIS® SGR should be installed internal to the motor if possible but may also be attached externally to the motor's end bracket.
- Use AEGIS® Colloidal Silver Shaft Coating (PN# CS015) on motor shaft where fibers touch.

**Product recommendation: AEGIS® SGR**

**!** Follow all safety precautions. MSDS available for download at [www.est-aegis.com](http://www.est-aegis.com)

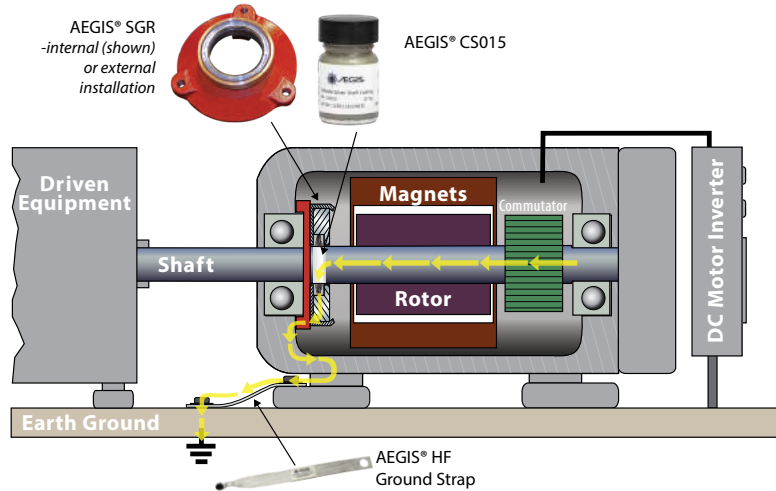

## DC Motors Greater than 10 HP (7.5 kW) - Operated on DC Inverter

### DC Motors:

- Non-Drive end: Bearing housing must be isolated with insulated sleeve or coating or use insulated ceramic or hybrid bearing to disrupt circulating currents.
- Drive end: Install one AEGIS® Shaft Grounding Ring to discharge induced shaft voltage.
- AEGIS® Ring should be installed internal to the motor if possible but may also be attached externally to the motor's end bracket.
- Use AEGIS® Colloidal Silver Shaft Coating (PN# CS015) on motor shaft where fibers touch.

**Product recommendation:**

- ♦ DC motors from 10HP to 300HP: **AEGIS® SGR**
- ♦ DC motors over 300HP: **AEGIS® PRO Series**

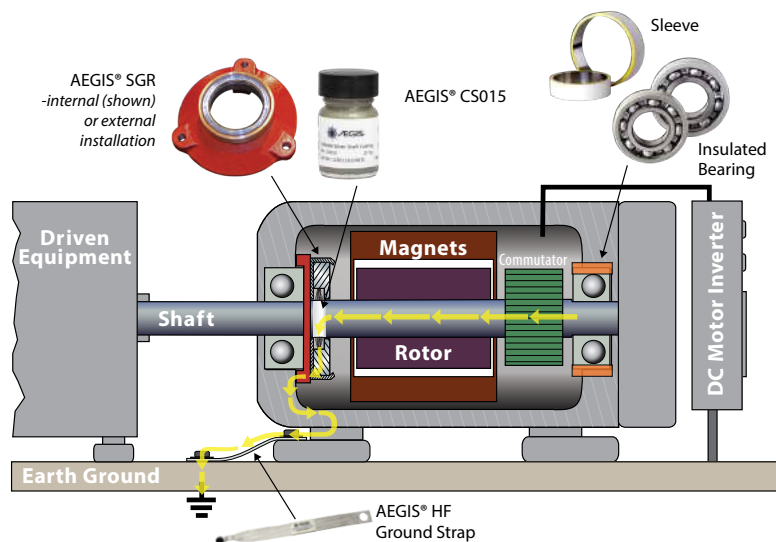

(1) EASA web seminar: Dealing with Shaft and Bearing Currents, Thomas H. Bishop, P.E., Electrical Apparatus Service Association, January 19, 2011





## AEGIS® Installation and Shaft Preparation

### AEGIS® Installation - Internal

AEGIS® Shaft Grounding Rings are ideally installed on the inside of the motor to provide protection from ingress of dirt and dust. Motor manufacturers commonly use this installation as a best practice in stock catalog motors equipped with AEGIS® rings.



Follow all safety precautions. GHS SDS for CS015 and EP2400 available for download at [www.est-aegis.com](http://www.est-aegis.com)



Follow AEGIS® best practices for motor shaft preparation and ring installation. Use AEGIS® Colloidal Silver Shaft Coating when installing AEGIS® rings to enhance the shaft conductivity and help prevent oxidation.



Press Fit Installation:

- Press into bearing retainer
- Press into custom bracket

Bore Specification: 0.002" – 0.004" interference [0.05 mm - .10 mm]

English: Ring OD tolerance +0 / -0.001" Bore tolerance +0.001 / -0"

Metric: Ring OD tolerance +0 / -0.025 mm Bore tolerance +0.025 / -0 mm



Bolt-through installation:

- Press into bearing retainer
- Press into custom bracket



Do not use non-conductive thread-lock

Drill/tap holes per AEGIS® Ring drawing location

- Flat head cap screws
- Socket head cap screws/lock washer



Use EP2400 Conductive Epoxy if thread lock is needed to secure the screws in place.



In some motors it may be desirable to attach an additional machined spacer to locate the ring further away from the bearing grease cavity.

A grease seal may be added to reduce grease ingress to the fibers.

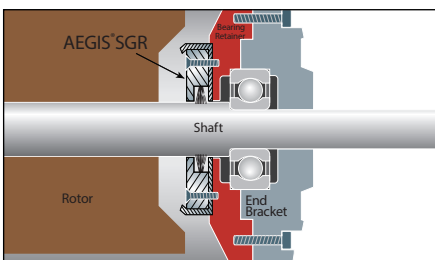

Common AEGIS® Ring installation internal to the motor is on the motor's bearing retainer. Installation can be done with bolt through hardware or AEGIS® Conductive Epoxy.

For epoxy installation, bearing retainer must be clean & free of any coatings, paint, or other nonconductive material where AEGIS® SGR will be mounted. This is the discharge path to ground therefore metal to metal contact is essential.



Epoxy Mounting – Internal

AEGIS® Conductive Epoxy was specially developed and tested to stringent vibration and pull test requirements to ensure a strong and reliable long term adhesive bond.



Do not use a substitute epoxy as only the AEGIS® EP2400 has been tested and approved for AEGIS® ring installation.



Patented Technology



## AEGIS® Installation - External

AEGIS® Shaft Grounding Rings may be installed on the outside of the motor but care must be taken to protect the ring from excessive ingress of dirt and dust.

- ❗ Follow AEGIS® best practices for motor shaft preparation and ring installation. Use AEGIS® Colloidal Silver Shaft Coating when installing AEGIS® rings to enhance the shaft conductivity and help prevent oxidation.
- An O-ring or V-slinger may be installed against the AEGIS® Ring to help prevent excessive ingress of dirt, dust or liquid.

Standard bracket or uKIT bracket Installation:

1. Standard Brackets (3 or 4 depending on ring size)
2. uKIT includes various bracket options
3. Custom brackets available

To view product line or download the AEGIS® Catalog visit [www.est-aegis.com](http://www.est-aegis.com)



Large Severe Duty AC and DC Motors: These motors are operated in severe environmental conditions where there is debris, powder, dirt, liquids, lubricants or other contaminants which can collect around the shaft of the motor. For these applications the AEGIS® PROSLR incorporates an O-ring dust and debris barrier to prevent ingress of these materials. See page 23.

Note: Some seal manufacturers such as Garlock and Flowserve provide bearing isolators with AEGIS® Rings installed inside.

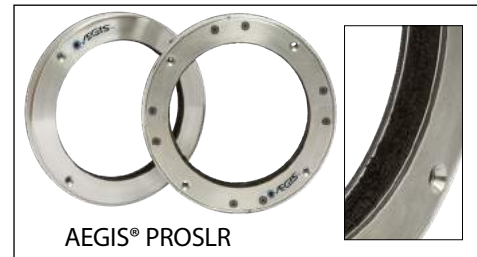

Bolt-through installation into:

- End Bracket
- Custom Bracket



Do not use non-conductive thread-lock

Drill/tap holes per AEGIS® Ring drawing location

- Flat head cap screws
- Socket head cap screws/lock washer



Use EP2400 Conductive Epoxy if thread lock is needed to secure the screws in place.



Epoxy Mounting – External

Motor end bracket must be clean & free of any coatings, paint, or other nonconductive material where AEGIS® SGR will be mounted using conductive epoxy. This is the discharge path to ground therefore metal to metal contact is essential.

Curing can be achieved in 4 hours at or above 75° F (24°C). For faster curing times, maximum conductivity and adhesion, heat the bond to between 150°-250° F (66°-121° C) for 10 minutes and allow to cool.

Pot-life is approximately 10 minutes at 75° F (24° C).

AEGIS® Conductive Epoxy was specially developed and tested to stringent vibration and pull test requirements to ensure a strong and reliable long term adhesive bond.



Do not use a substitute epoxy as only the AEGIS® EP2400 has been tested and approved for AEGIS® ring installation.

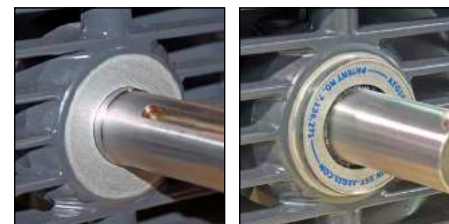

## Shaft Preparation for Internal and External Installation

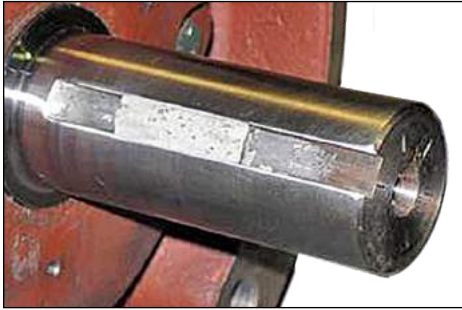

**AEGIS® Rings should not operate over a keyway** because the edges are very sharp. For proper performance:

Adjust or change spacer and screw lengths to avoid the keyway; or Fill the keyway (in the area where the AEGIS® microfibers will be in contact with the shaft) with a fast-curing epoxy putty such as Devcon® Plastic Steel® 5 Minute® Putty(SF).

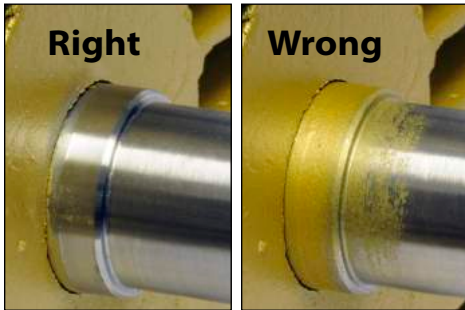

### Motor shaft must be conductive:

Shaft must be clean and free of any coatings, paint, or other nonconductive material (clean to bare metal). Depending on the condition of the shaft, it may require using emery cloth or Scotch-Brite™. If the shaft is visibly clean, a non petroleum based solvent may be used to remove any residue. If possible, check the conductivity of the shaft using an ohm meter.



### Ohms test:

Place the positive and negative meter leads on the shaft at a place where the microfibers will contact the shaft. Each motor will have a different reading but in general you should have a maximum reading of less than 2 ohms. If the reading is higher, clean the shaft again and retest.

Colloidal Silver Shaft Coating (CS015) is recommended for all applications (we don't recommend any substitutions). The silver enhances the conductivity of the shaft and also lessens the amount of corrosion that can impede the grounding path.

Treating the shaft of the motor prior to installing the AEGIS® Ring:

1. Shaft must be clean and free of any coatings, paint, or other nonconductive material. The shaft must be clean to bare metal.
2. If possible, gently warm the shaft when the AEGIS® CS015 will be applied. This helps the CS015 cure faster. Allow CS015 to come to room temperature prior to opening.
3. Apply a thin, uniform coat of the AEGIS® Colloidal Silver Shaft Coating to the area where the AEGIS® microfibers will be in contact with the motor shaft. Apply all around the shaft. Wait for the first coat to dry to a tack free surface. Drying can be accelerated with the use of gentle heat from a heat gun, but don't exceed 200°F (93°C) while curing.
4. Apply a 2nd thin, uniform coat of CS015.
5. Allow CS015 to dry to a tack free surface before installing the AEGIS® Ring.
6. Allow the CS015 to cure completely before running the motor. The coating will cure at room temperature in 16-20 hours or in about 60 minutes at 200°F (93°C).



Colloidal Silver Shaft Coating  
PN# CS015



Follow all safety precautions. GHS SDS for CS015 available for download at [www.est-aegis.com](http://www.est-aegis.com)



## Shaft Preparation continued

Install the AEGIS® SGR so that the aluminum frame maintains an even clearance around the shaft. AEGIS® conductive microfibers must be in contact with conductive metal surface of the shaft.



**Do not use thread lock to secure the mounting screws as it may compromise the conductive path to ground.**



If thread lock is required, use a small amount of EP2400 AEGIS® Conductive Epoxy to secure the screws in place.



After installation, test for a conductive path to ground using an Ohm meter. Place one probe on metal frame of AEGIS® SGR and one probe on motor frame.



Motor must be grounded to common earth ground with drive according to applicable standards.



Where AEGIS® SGR is exposed to excessive debris, additional protection of the AEGIS® SGR fibers may be necessary.

Install an O-ring or V-slinger against the ring.



For medium voltage and higher power motors in severe duty environments, the AEGIS® PRO SLR incorporates two specially customized O-rings to protect fibers from excessive dirt and grease.

For custom applications, contact AEGIS® Customer Service/Engineering for assistance.





## Shaft Voltage Testing - Measuring Shaft Voltages



**Shaft Voltage Test Report:** Measuring the shaft voltage on VFD driven motors provides the user with valuable information to determine if there is a potential risk of bearing damage from electrical bearing discharges. Surveying and documenting shaft voltage readings and waveforms will assist in determining the appropriate mitigation or solution.

Note: The best time for shaft voltage measurements is during initial start-up in new or repaired motors operated by the VFD. Shaft voltage measurements should be incorporated into preventive and predictive maintenance programs and may be combined with vibration analysis, thermography or other services.

Report template available at: [www.est-aegis.com/bearing](http://www.est-aegis.com/bearing)



AEGIS-OSC-9100MB-W2

### Recommended Testing Equipment:

AEGIS® Shaft Voltage Tester™ 100 MHz Digital Oscilloscope with a 10:1 Shaft Voltage Probe™ kit. We recommend a minimum 100MHz bandwidth to accurately measure the high frequency transitions associated with bearing discharge and VFD waveforms.

Recommended Product: PN: AEGIS-OSC-9100MB-W2

- Two 1X/10X probes, one with Shaft Voltage Probe™ SVP Tip attached
- 1000V CAT III multimeter test leads
- AEGIS® One-Touch™ instant image capture feature
- USB flash drive for waveform recording
- 5 hour+ rechargeable/replaceable Li battery
- Carrying case

### AEGIS® SVP Shaft Voltage Probe™

The AEGIS® SVP Shaft Voltage Probe™ tip attaches to an oscilloscope voltage probe to easily and accurately measure the voltage on a rotating shaft. The high density of conductive microfibers ensures continuous contact with the rotating shaft. The SVP-KIT-9100MB includes replacement tips, extender rods, a magnetic base/probe holder and AEGIS® Ring simulator.

Caution: Use appropriate safety procedures near rotating equipment.



PN: SVP-KIT-9100MB



## Examples of Shaft Voltage Readings

### High Peak to Peak common mode voltage –

Typically 20 to 120 volts peak to peak (10 to 60 volts peak). The waveform image shows the capacitive coupled common mode voltage on the shaft of the motor. The “six-step” wave form is the result of the 3 phases of pulses from the VFD. The timing of the pulse width modulation (PWM) pulses to the motor from the drive determines what the waveform looks like. Sometimes it will look like a square wave.

This six-step or square wave is what is seen when there is no bearing discharge and the peak to peak shaft voltage is at its maximum level. The voltage level may eventually overcome the dielectric in non-isolated bearings and begin discharging.

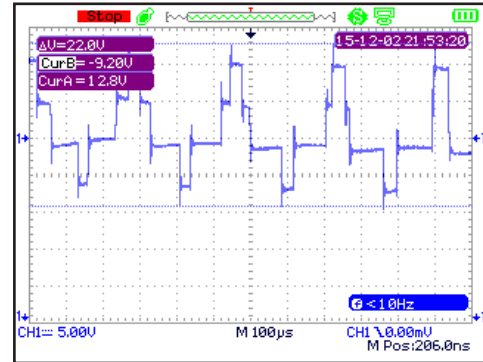

### High amplitude EDM discharge pattern –

Typically EDM discharges can occur from 20 to 80 volts peak to peak (10 to 40 volts peak) depending on the motor, the type of bearing, the age of the bearing, and other factors. The waveform image shows an increase in voltage on the shaft and then a sharp vertical line indicating a voltage discharge. This can occur thousands of times in a second, based on the carrier frequency of the drive. The sharp vertical discharge at the trailing edge of the voltage is an ultra high frequency dv/dt with a typical “discharge frequency” of 1 to 125 MHz (based on testing results in many applications).

Reference: NEMA MG1 Section 31.4.4.3

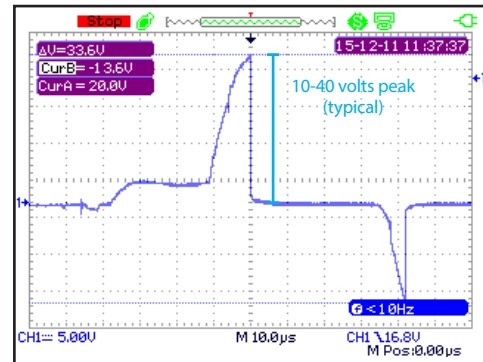

### Low amplitude voltage discharge pattern –

Typically the voltages are 4 to 15 volts peak to peak (2 to 8 volts peak). The waveform image shows a more continuous discharge pattern with lower dv/dt frequencies. The lower voltage may be due to greater current flow in the bearings which is the result of the bearing lubrication becoming conductive or could be a function of the motor’s drive, speed, loading or other factors. As discharges occur in the bearings, the lubrication is contaminated with carbon and metal particles. The lower impedance to the shaft voltages results in lower peak to peak voltages. This condition is usually found in motors that have been in operation for many months or years.

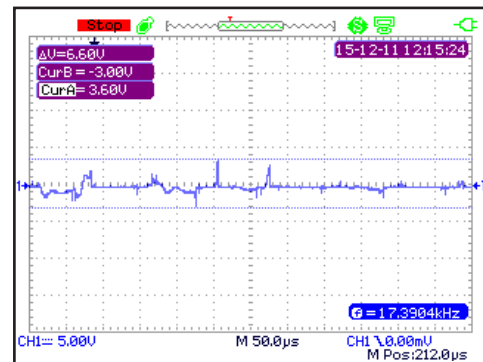

### Peak to Peak voltage with AEGIS® ring installed –

With the AEGIS® ring installed, a bare steel shaft will typically show shaft voltages of 2 to 10 volts peak to peak (1 to 5 volts peak) depending on the power of the motor, ground noise, the conductivity of the shaft and other factors. The voltage readings may be decreased further with the application of AEGIS® Colloidal Silver Shaft Coating which allows for higher shaft surface conductivity and a more efficient electron transfer to the conductive micro fiber tips.

The waveform image shows the low peak to peak waveform of a motor with the AEGIS® SGR ring installed and discharging the shaft voltages normally.

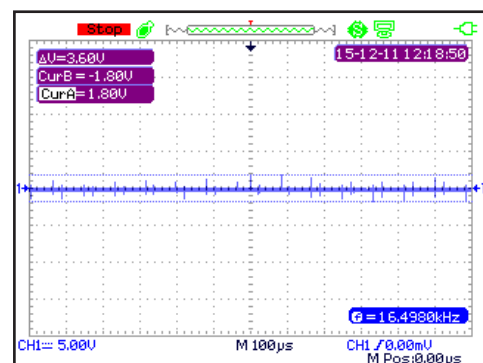



## AEGIS® Shaft Voltage Testing

## AEGIS-OSC-9100 Setup and Parameters



The following pages describe the settings and parameters we use to capture shaft voltages. For ease of use, the factory settings are preset for shaft voltage measurements.

To demonstrate, we will use the AEGIS-OSC-9100 Shaft Voltage Tester™ - a 2 channel - 100 MHz Digital Oscilloscope designed to easily capture shaft voltage measurements on operating equipment. Refer to your owner's manual or quick start for detailed instructions and explanations of other advanced functions.

The AEGIS® Shaft Voltage Tester™ may be reset to factory settings at any time using the procedure below.

## Setup: AEGIS® SVP Tip Installation

## AEGIS® Meter Probe PP510 10:1 probe



1. The AEGIS® Meter probe has an insulated sleeve over the tip. Do not remove this cover.

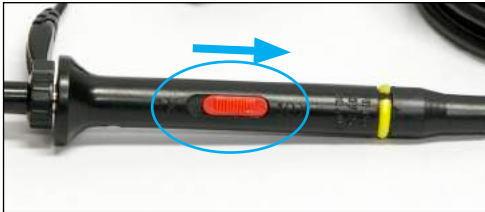

2. Set the probe to 10X.



3. Secure the AEGIS® probe tip using the thumb screw. Be careful not to over-tighten.



4. Connect 10:1 probe into Ch 1.

Note: The AEGIS® meter comes with one SVP probe tip already installed

## Setup: Factory Settings / Reset



1. Press **SAVE/RECALL**
2. **F1 TYPE**. Choose **FACTORY**. Press **▶**
3. **F5 LOAD**

## Default parameters included:

- DC Coupling
- Waveform Sampling
- Peak to Peak Voltage (Vpp) displayed on Measure screen

For the full list of factory settings, see the user manual included on the flash drive or online.

[www.est-aegis.com/tester-manual](http://www.est-aegis.com/tester-manual)



Patented Technology

### Setup: Select 10X Probe



Press **CH1** to bring up the CH1 menu on Page 1/3. (If a different page pops up, press **F5** to cycle back to Page 1/3). Press **F4 Probe**



Select **10X** with the blue up and down arrows and press **ENTER**. Press **MENU** to exit the **CH1** menu.



Be sure probe is set to 10X.

### Setup: Calibrating the Probe



Now the scope is set up to calibrate the probe. The AEGIS-OSC-9100 includes a two-pronged calibration dongle that plugs into the side of the scope. This micro-USB dongle generates a square wave used to fine-tune the probe.

Calibration must be done the first time a new probe is used, and should be checked periodically to ensure accurate waveform measurements.



Adjustment screw

Plug the dongle into the small USB port, clamp the probe ground lead to the lower prong, and touch the SVP Tip to the upper prong.



Press **AUTO**. The scope will display a train of approximately square waves of amplitude 3V and frequency 1 kHz.

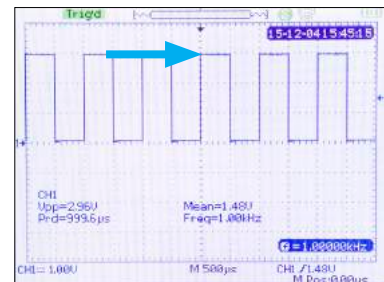

Using the included screwdriver with insulated handle, adjust the screw in the probe until the waves are displayed with square edges. The probe is now calibrated.

Remove dongle.



## AEGIS® Shaft Voltage Testing

### Menu Button

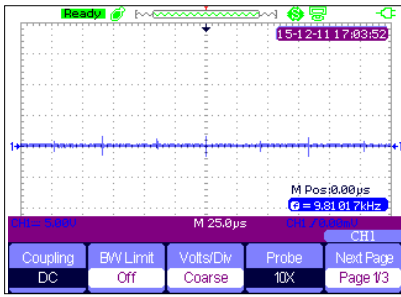

Here is the CH1 menu. Pressing **MENU** collapses it.

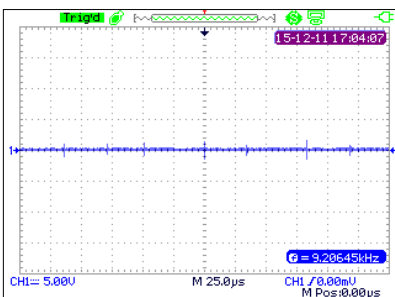

Pressing **MENU** again opens it back up.

The **MENU** button opens and closes the last menu viewed.

### Auto Button

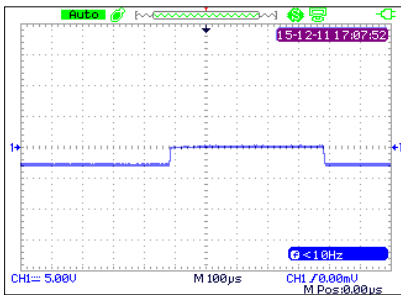

When viewing a waveform, pressing **AUTO** resizes the voltage and time scales to fit the waveform...

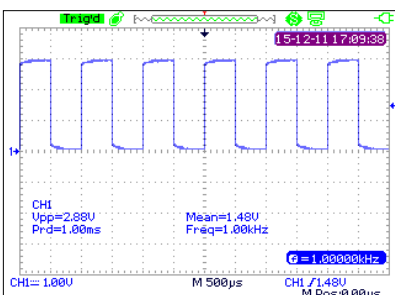

...and displays Vpp, right onscreen. This will remain until a menu is brought up.

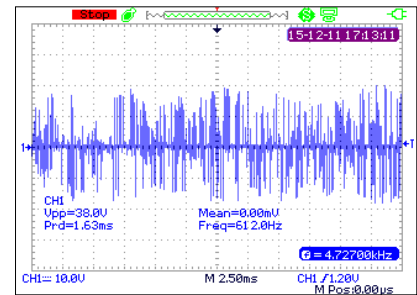

Caution: Shaft voltages are highly random so using **AUTO** mode may give too large a timescale. This can be adjusted. See Setting Time Period (page 39).

Note: Noise from the VFD may also cause CH2 to be displayed - even if no probe is plugged into the CH2 BNC. If this occurs, press **CH2** until the red trace disappears, and find Vpp using **Measure** or **Cursors** (page 41).

### Run/Stop Button



While making measurements, **RUN/STOP** freezes the screen. When stopped, the word **STOP** will appear in the upper left of the screen.

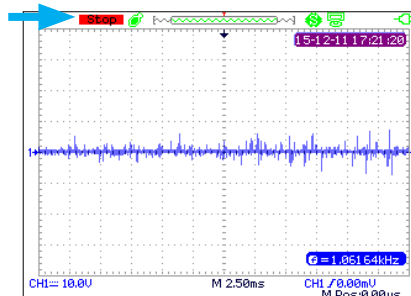

This enables you to analyze the waveform more easily and save if desired.

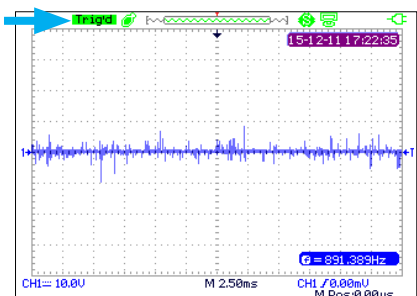

Pressing **RUN/STOP** again resumes measurement. Stop will change to Trig'd or Auto.



Patented Technology

## Setting Voltage Amplitude



An EDM discharge pattern will show a climb in voltage and then a sharp vertical line. The sharp vertical line shows the moment of discharge to ground. To get a good image of a discharge, you may need to adjust the display scale.

Control the vertical scale of the displayed signal by adjusting the volts per division. The entire signal, from peak to peak, should all be displayed on the screen. 5V is a good place to start, and then adjust up or down based on the conditions. The setting selected in volts per division is shown in the lower left of the screen.

Press "V" to decrease vertical sensitivity (shorter waveforms)



Press "mV" to increase vertical sensitivity (taller waveforms)

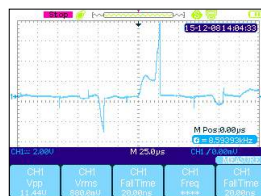

Amplitude will need to be adjusted according to the conditions. Set to show complete wave from top peak to bottom peak using the scale buttons.

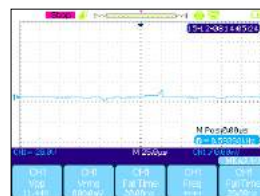

In this example the amplitude is too small. Increase the range (mV) to show more detail.

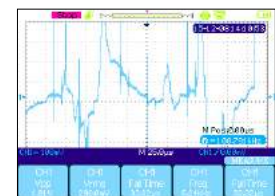

In this example the amplitude is too large. Decrease the range (V) to show top and bottom peaks.

## Setting Time Period



Control the horizontal scale of the displayed signal by adjusting the time scale. 500µs (microseconds) is a good place to start and then adjust the time based on the conditions. The selected seconds per division setting is shown at the bottom center of the screen. The EDM wave forms are best displayed at a setting of 50µs/div or less. Adjust the time setting to show the desired waveform.

Press "ns" to increase horizontal sensitivity (wider waveforms)

Press "s" to decrease horizontal sensitivity (narrower waveforms)



This is an example of a Time period set to 25 microseconds (25/1,000,000). It clearly shows a climb in voltage and a sharp discharge to ground.

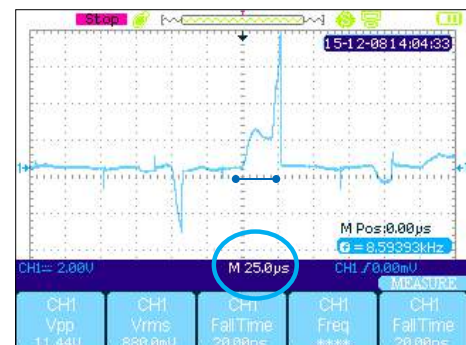



## AEGIS® Shaft Voltage Testing

### Adjusting Waveform Position

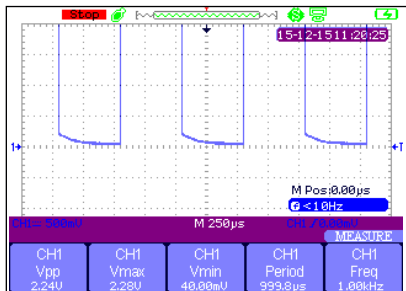

Some waveforms may display too high or low on the screen. This often happens when using the **MEASURE** window (described on page 41).



Waveforms' onscreen position can be adjusted by offsetting the voltage.

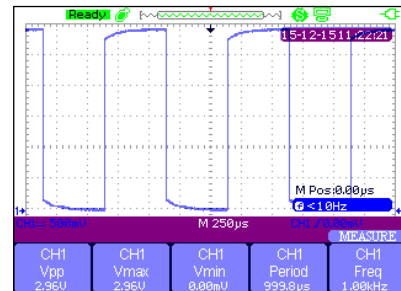

The up arrow moves the waveform higher onscreen & the down arrow moves it lower. The current offset level is indicated by the blue 1 and arrow at the extreme left of the screen.

The time can also be offset. The arrows under similarly move waveforms left and right.



### AEGIS® One-Touch™ Screen Capture Feature Saving Images as .BMP on USB

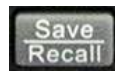

1. Plug in a USB drive – you will get a screen message "USB Flash Drive Plugged In!"
2. Hold the **SAVE/RECALL** button in for approximately six seconds until progress bar  appears near the bottom of the screen. 
3. When finished saving images, simply remove the USB Flash drive and view .BMP on computer

Screen capture may be done either during a "live view" or when the screen is paused:

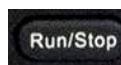
1. Press **RUN/STOP** to pause the screen. Voltage & time scales can be changed while screen is stopped. 
2. When the bars have disappeared, press **RUN/STOP** to resume live view.



Patented Technology



## Peak to Peak Voltage (Vpp) with Measure

The AEGIS-OSC-9100 offers three methods to measure peak to peak voltage (Vpp): **Measure**, and **Cursor**, and **Auto**. **Auto** was described in the Auto Button section (page 38).

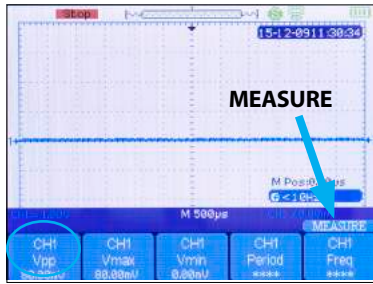

Press **CURSOR|MEASURE** until the **MEASURE** menu appears. If Vpp is listed above F1, skip the rest of this section. Otherwise, press **F1** to continue set up.



Press **F1 VOLTAGE**

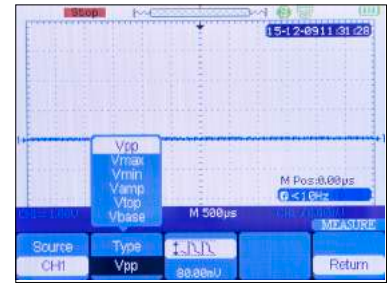

Press **F2 TYPE**. Choose **Vpp**, then press **F5 RETURN**

## Peak to Peak Voltage with Cursors

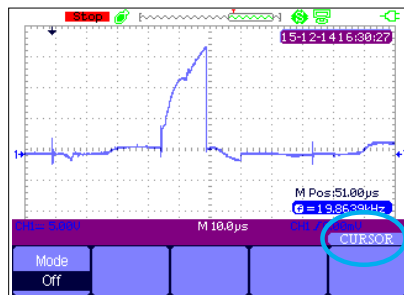

Press **CURSOR|MEASURE** until the **CURSOR** menu appears.

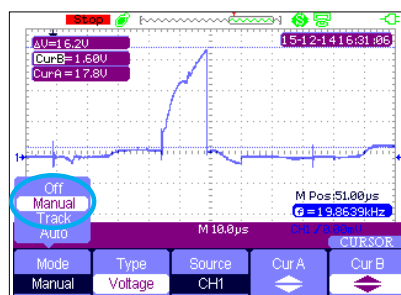

Press **F1 MODE**, select **Manual**, and press **F2**

Note: If TIME displays over **F2**, press **F2** until it changes to **VOLTAGE**.

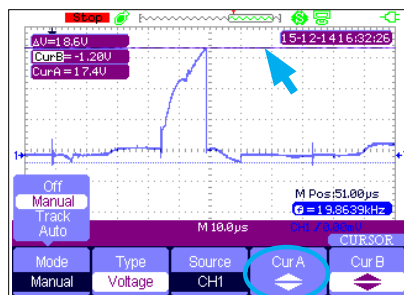

Press **F4 CurA** and use the blue **▲** & **▼** to move the upper cursor (emphasized above) to the top of discharge to be measured.

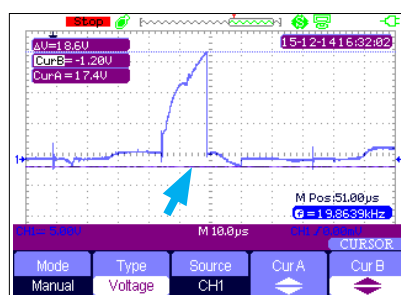

Press **F5 CurB** and use **▲** & **▼** to move the cursor to the bottom of the discharge to be measured.

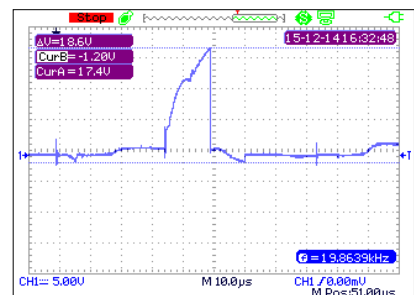

$\Delta V$  is the peak voltage of the discharge. For a better view, press **MENU** to collapse the cursor menu.



## AEGIS® Shaft Voltage Testing

### Taking the Measurements- EMI

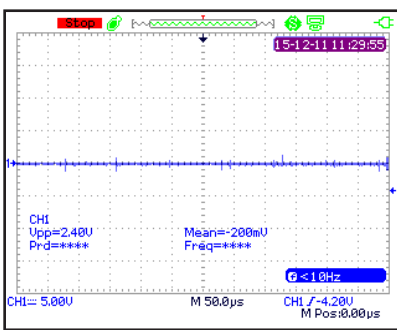
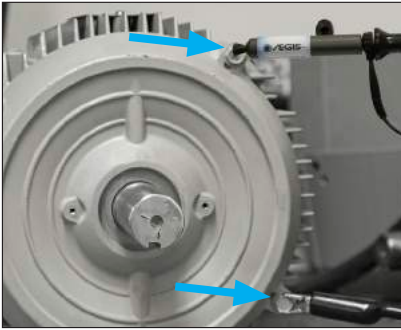

#### Ground Reference Reading: EMI

1. The reading displays ground noise or EMI being produced by the motor/drive system. This electrical noise may be present before and after installing the AEGIS® ring.
2. Find 2 ground points on the motor. Must be bare metal and conductive.
3. Place the SVP on one of the points and the probe grounding clip on the other point.
4. Measurements will vary depending on the motor size and conditions.

### Taking the Measurements- Shaft Voltage

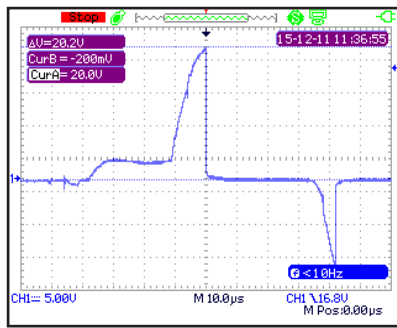
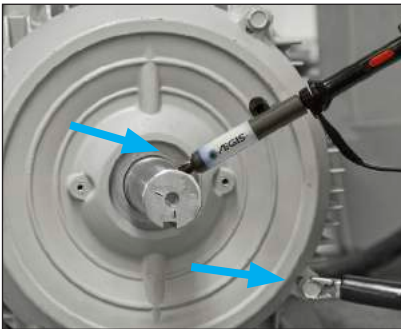

#### Shaft Voltage Reading

1. Shaft must be clean & free of any coatings, paint or other nonconductive material.
2. Secure the probe in place with magnetic base.
3. Align AEGIS® SVP on shaft end or side ensuring continuous contact. Avoid keyway if possible.
4. Place oscilloscope grounding lead on bare metal of motor ensuring conductive path to ground.
5. If this test is to be used in a report, save an image to a USB drive.



Follow all safety precaution when working with rotating equipment.



## Measurements Using the AEGIS® Grounding Simulator™

The AEGIS® Grounding Simulator™ can be used to simulate how the shaft voltages will change after an AEGIS® Ring is installed. It is a quick way of showing a "Before & After" but since only a small amount of conductive microfibers are touching the shaft the shaft voltage may be higher than when the circumferential AEGIS® Ring is installed.

1. Take the Shaft Voltage Reading without Shaft Grounding
2. Take the Shaft Voltage Reading with the AEGIS® Grounding Simulator™



### First Take the Shaft Voltage Reading without Shaft Grounding

1. Shaft must be clean & free of any coatings, paint or other nonconductive material.
2. Secure the probe in place with magnetic base.
3. Align AEGIS® SVP™ on shaft end or side ensuring continuous contact. Avoid keyway if possible.
4. Place probe grounding lead on bare metal of motor ensuring conductive path to ground.
5. Save the image, as described on page 40.

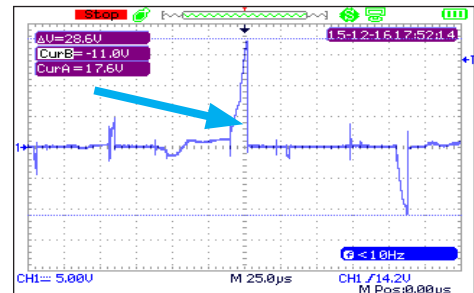
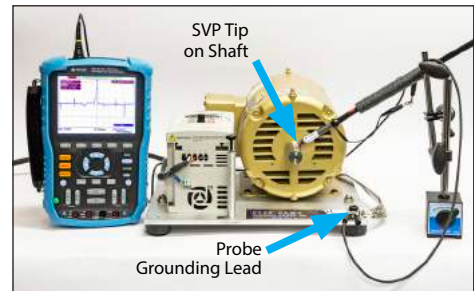

The voltage measurement of 28.6V peak to peak is an example of the voltage discharging through the bearings without AEGIS® shaft grounding.

Follow all safety precaution when working with rotating equipment.

### Next Take the Shaft Voltage Reading with the Grounding Simulator™ Touching the Shaft

1. Maintain the same setup as above.
2. Place the AEGIS® Grounding Simulator™ grounding lead on bare metal of motor ensuring conductive path to ground.
3. Place the Simulator against the shaft to simulate the AEGIS® SGR Bearing Protection Ring.
4. Freeze the screen and save the image.

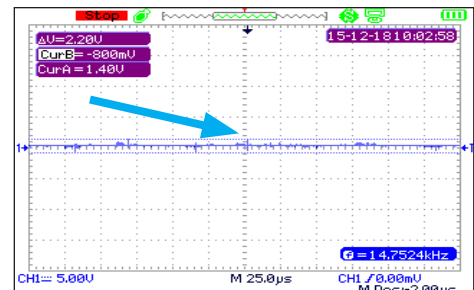
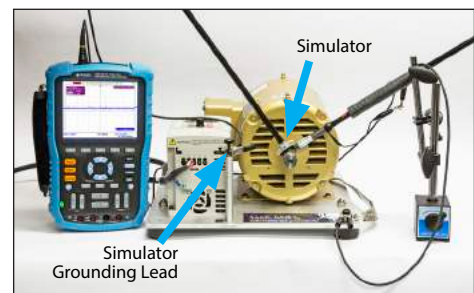

The voltage measurement of 2.2V peak to peak is an example of the voltage discharging through the AEGIS® Grounding Simulator to ground. The AEGIS® SGR Bearing Protection Ring will perform equally or better.

Follow all safety precaution when working with rotating equipment.



## Selecting the Correct Size Ring

**!** For standard NEMA or IEC frame motors, the AEGIS® uKIT is the best option. It avoids most shaft shoulders and slingers/seals.

AEGIS® uKIT includes 4 different bracket sizes to suit most situations.

**STOP** Question to ask: **Does the motor have a shaft shoulder?**

If **YES or NOT SURE**, then the AEGIS® uKIT is the easiest option because it avoids the shaft shoulder area, any slingers/seals or irregular shaped end bracket.

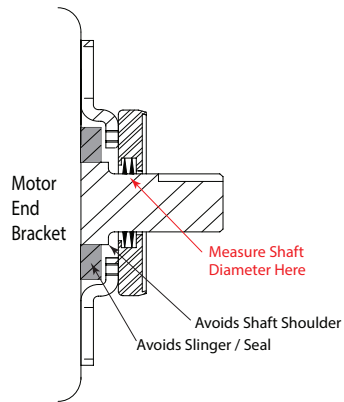

AEGIS® uKIT is attached to motor with screws/washers provided or with conductive epoxy. AEGIS® EP2400 Conductive Epoxy sold separately.

See AEGIS® website for bolt hole circle and installation instructions. See page 49 for more details.

If **NO**, the ring can be mounted directly to the end bracket using screws or conductive epoxy.

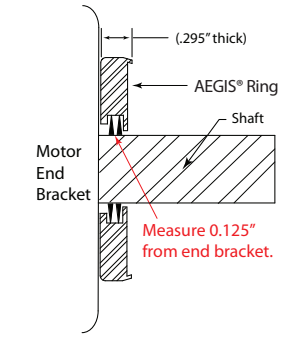

Measure shaft diameter at a point 0.125" from motor end bracket. Then refer to the parts list to locate the correct part number and mounting option of your choosing.

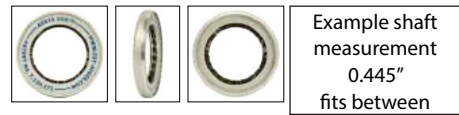

Example shaft measurement 0.445" fits between

Solid Ring Catalog Number	Split Ring Catalog Number	Bolt Through Catalog Number	Solid Ring with Conductive Epoxy	Split Ring with Conductive Epoxy	Min. Shaft Diameter	Max. Shaft Diameter
SGR-9.0-1	SGR-9.0-1A4	SGR-9.0-3FH	SGR-9.0-0AW	SGR-9.0-0A4W	0.396	0.435
SGR-10.1-1	SGR-10.1-1A4	SGR-10.1-3FH	SGR-10.1-0AW	SGR-10.1-0A4W	0.436	0.480
SGR-11.2-1	SGR-11.2-1A4	SGR-11.2-3FH	SGR-11.2-0AW	SGR-11.2-0A4W	0.481	0.520

If **YES** and you want to mount the ring to fit the shaft shoulder then you need to measure the length of the shoulder. See note in red below. If still applicable, measure shaft shoulder diameter then refer to parts list (as shown above) to locate the correct SGR part number.

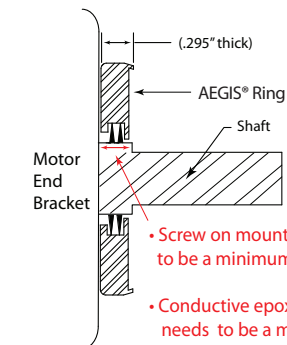

**Custom Option for Short Shaft Shoulders:** If the shaft shoulder is between .1875" and 0.375" we offer a custom part with fibers closer to the back of the ring. To order this option, add an "X" or "AX" to the suffix of the part.

**Example:**

**Standard SGR**  
 PN: SGR-6.9-0A4W  
 PN: SGR-6.9-0AW  
 PN: SGR-6.9-1  
 PN: SGR-6.9-1A4  
 PN: SGR-6.9-3FH

**Short Shoulder SGR**  
 PN: SGR-6.9-0A4WX  
 PN: SGR-6.9-0AWX  
 PN: SGR-6.9-1AX  
 PN: SGR-6.9-1A4X  
 PN: SGR-6.9-3FHAX

If the shoulder is less than 0.1875", then refer to the uKIT.



Patented Technology



## AEGIS® SGR Bearing Protection Ring Options



pg. 46-47 **Standard Mounting Clamps (-1)**  
 Shaft diameters: 0.311" to 6.02"  
 3 to 4 mounting clamps, 6-32 x 1/4" cap screws and washers  
 Quick and easy installation to most surfaces

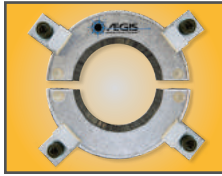

pg. 46-47 **Split Ring (-1A4)**  
 Shaft diameter: 0.311" to 6.02"  
 4 to 6 mounting clamps, 6-32 x 1/4" cap screws and washers  
 Installs without decoupling motor



pg. 46-47 **Bolt Through Mounting (-3FH)**  
 Shaft diameters: 0.311" to 6.02"  
 6-32 x 1/2" flat head screws  
 2 mounting holes up to shaft size 3.395"  
 4 mounting holes for larger sizes



pg. 46-47 **Conductive Epoxy Mounting (-0AW, -0A4W)**  
 Shaft diameters: 0.311" to 6.02"  
 Solid and Split Ring  
 Quick and easy installation to metal motor frame  
 Conductive Epoxy Included



pg. 48 **Press Fit Mounting (-0A6)**  
 Shaft diameters: 0.311" to 6.02"  
 Clean dry 0.004" press fit  
 Custom sizes available



pg. 49 **uKIT - SGR with Universal Mounting Bracket**  
 Sized for NEMA and IEC Frame motors  
 Solid and Split Ring  
 Can be mounted with hardware or conductive epoxy

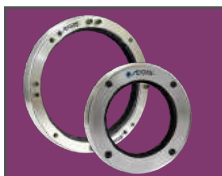

pg. 50-51 **AEGIS® PRO Series and WTG**  
 6 rows of conductive microfiber  
 AEGIS® PRO Series  
 AEGIS® WTG for Wind Turbine Generators

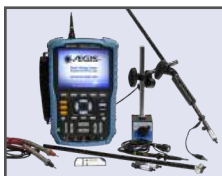

pg. 52 **AEGIS® Shaft Voltage Tester™**  
 AEGIS® Shaft Voltage Tester™  
 SVP - AEGIS® Shaft Voltage Probe



pg. 53 **Accessories**  
 HFGS - High-Frequency Ground Strap  
 CS015 - AEGIS® Colloidal Silver Shaft Coating  
 EP2400 - AEGIS® Conductive Epoxy

BEARING CURRENTS

MOTOR GROUNDING

AEGIS® TECHNOLOGY

LOW VOLTAGE MOTORS

MED VOLTAGE MOTORS

DC MOTORS

INSTALL SHAFT PREP

SHAFT VOLTAGE TESTING

SELECT CORRECT SIZE

PARTS LIST

ENGINEERING SPEC



## AEGIS® Shaft Grounding Ring Parts List

## Solid Ring, Split Ring, and Bolt Through Mounting for Low Voltage Motors to 500 HP

Dimensions in inches

Solid Ring Catalog Number	Split Ring* Catalog Number	Bolt Through Catalog Number	Solid Ring with Conductive Epoxy	Split Ring* with Conductive Epoxy	Min. Shaft Diameter	Max. Shaft Diameter	Outside Diameter	Thickness Max
SGR-6.9-1	SGR-6.9-1A4	SGR-6.9-3FH	SGR-6.9-0AW	SGR-6.9-0A4W	0.311	0.355	1.60	0.295
SGR-8.0-1	SGR-8.0-1A4	SGR-8.0-3FH	SGR-8.0-0AW	SGR-8.0-0A4W	0.356	0.395	1.60	0.295
SGR-9.0-1	SGR-9.0-1A4	SGR-9.0-3FH	SGR-9.0-0AW	SGR-9.0-0A4W	0.396	0.435	1.60	0.295
SGR-10.1-1	SGR-10.1-1A4	SGR-10.1-3FH	SGR-10.1-0AW	SGR-10.1-0A4W	0.436	0.480	1.60	0.295
SGR-11.2-1	SGR-11.2-1A4	SGR-11.2-3FH	SGR-11.2-0AW	SGR-11.2-0A4W	0.481	0.520	1.60	0.295
SGR-12.2-1	SGR-12.2-1A4	SGR-12.2-3FH	SGR-12.2-0AW	SGR-12.2-0A4W	0.521	0.560	1.60	0.295
SGR-13.2-1	SGR-13.2-1A4	SGR-13.2-3FH	SGR-13.2-0AW	SGR-13.2-0A4W	0.561	0.605	1.60	0.295
SGR-14.4-1	SGR-14.4-1A4	SGR-14.4-3FH	SGR-14.4-0AW	SGR-14.4-0A4W	0.606	0.645	1.60	0.295
SGR-15.4-1	SGR-15.4-1A4	SGR-15.4-3FH	SGR-15.4-0AW	SGR-15.4-0A4W	0.646	0.685	2.10	0.295
SGR-16.4-1	SGR-16.4-1A4	SGR-16.4-3FH	SGR-16.4-0AW	SGR-16.4-0A4W	0.686	0.730	2.10	0.295
SGR-17.6-1	SGR-17.6-1A4	SGR-17.6-3FH	SGR-17.6-0AW	SGR-17.6-0A4W	0.731	0.774	2.10	0.295
SGR-18.7-1	SGR-18.7-1A4	SGR-18.7-3FH	SGR-18.7-0AW	SGR-18.7-0A4W	0.775	0.815	2.10	0.295
SGR-19.7-1	SGR-19.7-1A4	SGR-19.7-3FH	SGR-19.7-0AW	SGR-19.7-0A4W	0.816	0.855	2.10	0.295
SGR-20.7-1	SGR-20.7-1A4	SGR-20.7-3FH	SGR-20.7-0AW	SGR-20.7-0A4W	0.856	0.895	2.10	0.295
SGR-21.7-1	SGR-21.7-1A4	SGR-21.7-3FH	SGR-21.7-0AW	SGR-21.7-0A4W	0.896	0.935	2.10	0.295
SGR-22.8-1	SGR-22.8-1A4	SGR-22.8-3FH	SGR-22.8-0AW	SGR-22.8-0A4W	0.936	0.980	2.10	0.295
SGR-23.9-1	SGR-23.9-1A4	SGR-23.9-3FH	SGR-23.9-0AW	SGR-23.9-0A4W	0.981	1.020	2.10	0.295
SGR-24.9-1	SGR-24.9-1A4	SGR-24.9-3FH	SGR-24.9-0AW	SGR-24.9-0A4W	1.021	1.060	2.10	0.295
SGR-25.9-1	SGR-25.9-1A4	SGR-25.9-3FH	SGR-25.9-0AW	SGR-25.9-0A4W	1.061	1.105	2.10	0.295
SGR-27.1-1	SGR-27.1-1A4	SGR-27.1-3FH	SGR-27.1-0AW	SGR-27.1-0A4W	1.106	1.145	2.10	0.295
SGR-28.1-1	SGR-28.1-1A4	SGR-28.1-3FH	SGR-28.1-0AW	SGR-28.1-0A4W	1.146	1.185	2.10	0.295
SGR-29.1-1	SGR-29.1-1A4	SGR-29.1-3FH	SGR-29.1-0AW	SGR-29.1-0A4W	1.186	1.230	2.10	0.295
SGR-30.3-1	SGR-30.3-1A4	SGR-30.3-3FH	SGR-30.3-0AW	SGR-30.3-0A4W	1.231	1.270	2.10	0.295
SGR-31.3-1	SGR-31.3-1A4	SGR-31.3-3FH	SGR-31.3-0AW	SGR-31.3-0A4W	1.271	1.310	2.10	0.295
SGR-32.3-1	SGR-32.3-1A4	SGR-32.3-3FH	SGR-32.3-0AW	SGR-32.3-0A4W	1.311	1.355	2.10	0.295
SGR-33.4-1	SGR-33.4-1A4	SGR-33.4-3FH	SGR-33.4-0AW	SGR-33.4-0A4W	1.356	1.395	2.10	0.295
SGR-34.4-1	SGR-34.4-1A4	SGR-34.4-3FH	SGR-34.4-0AW	SGR-34.4-0A4W	1.396	1.435	2.68	0.295
SGR-35.5-1	SGR-35.5-1A4	SGR-35.5-3FH	SGR-35.5-0AW	SGR-35.5-0A4W	1.436	1.480	2.68	0.295
SGR-36.6-1	SGR-36.6-1A4	SGR-36.6-3FH	SGR-36.6-0AW	SGR-36.6-0A4W	1.481	1.520	2.68	0.295
SGR-37.6-1	SGR-37.6-1A4	SGR-37.6-3FH	SGR-37.6-0AW	SGR-37.6-0A4W	1.521	1.560	2.68	0.295
SGR-38.6-1	SGR-38.6-1A4	SGR-38.6-3FH	SGR-38.6-0AW	SGR-38.6-0A4W	1.561	1.605	2.68	0.295
SGR-39.8-1	SGR-39.8-1A4	SGR-39.8-3FH	SGR-39.8-0AW	SGR-39.8-0A4W	1.606	1.645	2.68	0.295
SGR-40.8-1	SGR-40.8-1A4	SGR-40.8-3FH	SGR-40.8-0AW	SGR-40.8-0A4W	1.646	1.685	2.68	0.295
SGR-41.8-1	SGR-41.8-1A4	SGR-41.8-3FH	SGR-41.8-0AW	SGR-41.8-0A4W	1.686	1.730	2.68	0.295
SGR-43.0-1	SGR-43.0-1A4	SGR-43.0-3FH	SGR-43.0-0AW	SGR-43.0-0A4W	1.731	1.770	2.68	0.295
SGR-44.0-1	SGR-44.0-1A4	SGR-44.0-3FH	SGR-44.0-0AW	SGR-44.0-0A4W	1.771	1.810	2.68	0.295
SGR-45.0-1	SGR-45.0-1A4	SGR-45.0-3FH	SGR-45.0-0AW	SGR-45.0-0A4W	1.811	1.855	2.68	0.295
SGR-46.1-1	SGR-46.1-1A4	SGR-46.1-3FH	SGR-46.1-0AW	SGR-46.1-0A4W	1.856	1.895	2.68	0.295
SGR-47.1-1	SGR-47.1-1A4	SGR-47.1-3FH	SGR-47.1-0AW	SGR-47.1-0A4W	1.896	1.935	2.68	0.295
SGR-48.2-1	SGR-48.2-1A4	SGR-48.2-3FH	SGR-48.2-0AW	SGR-48.2-0A4W	1.936	1.980	2.68	0.295
SGR-49.3-1	SGR-49.3-1A4	SGR-49.3-3FH	SGR-49.3-0AW	SGR-49.3-0A4W	1.981	2.020	2.68	0.295
SGR-50.3-1	SGR-50.3-1A4	SGR-50.3-3FH	SGR-50.3-0AW	SGR-50.3-0A4W	2.021	2.060	3.10	0.295
SGR-51.3-1	SGR-51.3-1A4	SGR-51.3-3FH	SGR-51.3-0AW	SGR-51.3-0A4W	2.061	2.105	3.10	0.295
SGR-52.5-1	SGR-52.5-1A4	SGR-52.5-3FH	SGR-52.5-0AW	SGR-52.5-0A4W	2.106	2.145	3.10	0.295
SGR-53.5-1	SGR-53.5-1A4	SGR-53.5-3FH	SGR-53.5-0AW	SGR-53.5-0A4W	2.146	2.185	3.10	0.295
SGR-54.5-1	SGR-54.5-1A4	SGR-54.5-3FH	SGR-54.5-0AW	SGR-54.5-0A4W	2.186	2.230	3.10	0.295
SGR-55.7-1	SGR-55.7-1A4	SGR-55.7-3FH	SGR-55.7-0AW	SGR-55.7-0A4W	2.231	2.270	3.10	0.295
SGR-56.7-1	SGR-56.7-1A4	SGR-56.7-3FH	SGR-56.7-0AW	SGR-56.7-0A4W	2.271	2.310	3.10	0.295
SGR-57.7-1	SGR-57.7-1A4	SGR-57.7-3FH	SGR-57.7-0AW	SGR-57.7-0A4W	2.311	2.355	3.10	0.295
SGR-58.8-1	SGR-58.8-1A4	SGR-58.8-3FH	SGR-58.8-0AW	SGR-58.8-0A4W	2.356	2.395	3.10	0.295
SGR-59.8-1	SGR-59.8-1A4	SGR-59.8-3FH	SGR-59.8-0AW	SGR-59.8-0A4W	2.396	2.435	3.60	0.295
SGR-60.9-1	SGR-60.9-1A4	SGR-60.9-3FH	SGR-60.9-0AW	SGR-60.9-0A4W	2.436	2.480	3.60	0.295
SGR-62.0-1	SGR-62.0-1A4	SGR-62.0-3FH	SGR-62.0-0AW	SGR-62.0-0A4W	2.481	2.520	3.60	0.295
SGR-63.0-1	SGR-63.0-1A4	SGR-63.0-3FH	SGR-63.0-0AW	SGR-63.0-0A4W	2.521	2.560	3.60	0.295
SGR-64.0-1	SGR-64.0-1A4	SGR-64.0-3FH	SGR-64.0-0AW	SGR-64.0-0A4W	2.561	2.605	3.60	0.295
SGR-65.2-1	SGR-65.2-1A4	SGR-65.2-3FH	SGR-65.2-0AW	SGR-65.2-0A4W	2.606	2.645	3.60	0.295
SGR-66.2-1	SGR-66.2-1A4	SGR-66.2-3FH	SGR-66.2-0AW	SGR-66.2-0A4W	2.646	2.685	3.60	0.295
SGR-67.2-1	SGR-67.2-1A4	SGR-67.2-3FH	SGR-67.2-0AW	SGR-67.2-0A4W	2.686	2.730	3.60	0.295
SGR-68.4-1	SGR-68.4-1A4	SGR-68.4-3FH	SGR-68.4-0AW	SGR-68.4-0A4W	2.731	2.770	3.60	0.295
SGR-69.4-1	SGR-69.4-1A4	SGR-69.4-3FH	SGR-69.4-0AW	SGR-69.4-0A4W	2.771	2.810	3.60	0.295
SGR-70.4-1	SGR-70.4-1A4	SGR-70.4-3FH	SGR-70.4-0AW	SGR-70.4-0A4W	2.811	2.855	3.60	0.295
SGR-71.5-1	SGR-71.5-1A4	SGR-71.5-3FH	SGR-71.5-0AW	SGR-71.5-0A4W	2.856	2.895	3.60	0.295
SGR-72.5-1	SGR-72.5-1A4	SGR-72.5-3FH	SGR-72.5-0AW	SGR-72.5-0A4W	2.896	2.935	4.10	0.295
SGR-73.6-1	SGR-73.6-1A4	SGR-73.6-3FH	SGR-73.6-0AW	SGR-73.6-0A4W	2.936	2.980	4.10	0.295
SGR-74.7-1	SGR-74.7-1A4	SGR-74.7-3FH	SGR-74.7-0AW	SGR-74.7-0A4W	2.981	3.020	4.10	0.295
SGR-75.7-1	SGR-75.7-1A4	SGR-75.7-3FH	SGR-75.7-0AW	SGR-75.7-0A4W	3.021	3.060	4.10	0.295
SGR-76.7-1	SGR-76.7-1A4	SGR-76.7-3FH	SGR-76.7-0AW	SGR-76.7-0A4W	3.061	3.105	4.10	0.295
SGR-77.9-1	SGR-77.9-1A4	SGR-77.9-3FH	SGR-77.9-0AW	SGR-77.9-0A4W	3.106	3.145	4.10	0.295
SGR-78.9-1	SGR-78.9-1A4	SGR-78.9-3FH	SGR-78.9-0AW	SGR-78.9-0A4W	3.146	3.185	4.10	0.295

\*Custom Part-No Return

\*Custom Part-No Return



Patented Technology

Note: Use PRO Series Rings for Low Voltage Motors Greater than 500 HP and All Medium Voltage Motors

See page 22

Solid Ring Catalog Number	Split Ring* Catalog Number	Bolt Through Catalog Number	Solid Ring with Conductive Epoxy	Split Ring* with Conductive Epoxy	Min. Shaft Diameter	Max. Shaft Diameter	Outside Diameter	Thickness Max
SGR-79.9-1	SGR-79.9-1A4	SGR-79.9-3FH	SGR-79.9-0AW	SGR-79.9-0A4W	3.186	3.230	4.10	0.295
SGR-81.1-1	SGR-81.1-1A4	SGR-81.1-3FH	SGR-81.1-0AW	SGR-81.1-0A4W	3.231	3.270	4.10	0.295
SGR-82.1-1	SGR-82.1-1A4	SGR-82.1-3FH	SGR-82.1-0AW	SGR-82.1-0A4W	3.271	3.310	4.10	0.295
SGR-83.1-1	SGR-83.1-1A4	SGR-83.1-3FH	SGR-83.1-0AW	SGR-83.1-0A4W	3.311	3.355	4.10	0.295
SGR-84.2-1	SGR-84.2-1A4	SGR-84.2-3FH	SGR-84.2-0AW	SGR-84.2-0A4W	3.356	3.395	4.10	0.295
SGR-85.2-1	SGR-85.2-1A4	SGR-85.2-3FH	SGR-85.2-0AW	SGR-85.2-0A4W	3.396	3.435	4.60	0.295
SGR-86.3-1	SGR-86.3-1A4	SGR-86.3-3FH	SGR-86.3-0AW	SGR-86.3-0A4W	3.436	3.480	4.60	0.295
SGR-87.4-1	SGR-87.4-1A4	SGR-87.4-3FH	SGR-87.4-0AW	SGR-87.4-0A4W	3.481	3.520	4.60	0.295
SGR-88.4-1	SGR-88.4-1A4	SGR-88.4-3FH	SGR-88.4-0AW	SGR-88.4-0A4W	3.521	3.560	4.60	0.295
SGR-89.4-1	SGR-89.4-1A4	SGR-89.4-3FH	SGR-89.4-0AW	SGR-89.4-0A4W	3.561	3.605	4.60	0.295
SGR-90.6-1	SGR-90.6-1A4	SGR-90.6-3FH	SGR-90.6-0AW	SGR-90.6-0A4W	3.606	3.645	4.60	0.295
SGR-91.6-1	SGR-91.6-1A4	SGR-91.6-3FH	SGR-91.6-0AW	SGR-91.6-0A4W	3.646	3.685	4.60	0.295
SGR-92.6-1	SGR-92.6-1A4	SGR-92.6-3FH	SGR-92.6-0AW	SGR-92.6-0A4W	3.686	3.730	4.60	0.295
SGR-93.8-1	SGR-93.8-1A4	SGR-93.8-3FH	SGR-93.8-0AW	SGR-93.8-0A4W	3.731	3.770	4.60	0.295
SGR-94.8-1	SGR-94.8-1A4	SGR-94.8-3FH	SGR-94.8-0AW	SGR-94.8-0A4W	3.771	3.810	4.60	0.295
SGR-95.8-1	SGR-95.8-1A4	SGR-95.8-3FH	SGR-95.8-0AW	SGR-95.8-0A4W	3.811	3.855	4.60	0.295
SGR-96.9-1	SGR-96.9-1A4	SGR-96.9-3FH	SGR-96.9-0AW	SGR-96.9-0A4W	3.856	3.895	4.60	0.295
SGR-97.9-1	SGR-97.9-1A4	SGR-97.9-3FH	SGR-97.9-0AW	SGR-97.9-0A4W	3.896	3.935	5.10	0.295
SGR-99.0-1	SGR-99.0-1A4	SGR-99.0-3FH	SGR-99.0-0AW	SGR-99.0-0A4W	3.936	3.980	5.10	0.295
SGR-100.1-1	SGR-100.1-1A4	SGR-100.1-3FH	SGR-100.1-0AW	SGR-100.1-0A4W	3.981	4.020	5.10	0.295
SGR-101.1-1	SGR-101.1-1A4	SGR-101.1-3FH	SGR-101.1-0AW	SGR-101.1-0A4W	4.021	4.060	5.10	0.295
SGR-102.1-1	SGR-102.1-1A4	SGR-102.1-3FH	SGR-102.1-0AW	SGR-102.1-0A4W	4.061	4.105	5.10	0.295
SGR-103.3-1	SGR-103.3-1A4	SGR-103.3-3FH	SGR-103.3-0AW	SGR-103.3-0A4W	4.106	4.145	5.10	0.295
SGR-104.3-1	SGR-104.3-1A4	SGR-104.3-3FH	SGR-104.3-0AW	SGR-104.3-0A4W	4.146	4.185	5.10	0.295
SGR-105.3-1	SGR-105.3-1A4	SGR-105.3-3FH	SGR-105.3-0AW	SGR-105.3-0A4W	4.186	4.230	5.10	0.295
SGR-106.5-1	SGR-106.5-1A4	SGR-106.5-3FH	SGR-106.5-0AW	SGR-106.5-0A4W	4.231	4.270	5.10	0.295
SGR-107.5-1	SGR-107.5-1A4	SGR-107.5-3FH	SGR-107.5-0AW	SGR-107.5-0A4W	4.271	4.310	5.10	0.295
SGR-108.5-1	SGR-108.5-1A4	SGR-108.5-3FH	SGR-108.5-0AW	SGR-108.5-0A4W	4.311	4.355	5.10	0.295
SGR-109.6-1	SGR-109.6-1A4	SGR-109.6-3FH	SGR-109.6-0AW	SGR-109.6-0A4W	4.356	4.395	5.10	0.295
SGR-110.6-1	SGR-110.6-1A4	SGR-110.6-3FH	SGR-110.6-0AW	SGR-110.6-0A4W	4.396	4.435	5.60	0.295
SGR-111.7-1	SGR-111.7-1A4	SGR-111.7-3FH	SGR-111.7-0AW	SGR-111.7-0A4W	4.436	4.480	5.60	0.295
SGR-112.8-1	SGR-112.8-1A4	SGR-112.8-3FH	SGR-112.8-0AW	SGR-112.8-0A4W	4.481	4.520	5.60	0.295
SGR-113.8-1	SGR-113.8-1A4	SGR-113.8-3FH	SGR-113.8-0AW	SGR-113.8-0A4W	4.521	4.560	5.60	0.295
SGR-114.8-1	SGR-114.8-1A4	SGR-114.8-3FH	SGR-114.8-0AW	SGR-114.8-0A4W	4.561	4.605	5.60	0.295
SGR-116.0-1	SGR-116.0-1A4	SGR-116.0-3FH	SGR-116.0-0AW	SGR-116.0-0A4W	4.606	4.645	5.60	0.295
SGR-117.0-1	SGR-117.0-1A4	SGR-117.0-3FH	SGR-117.0-0AW	SGR-117.0-0A4W	4.646	4.685	5.60	0.295
SGR-118.0-1	SGR-118.0-1A4	SGR-118.0-3FH	SGR-118.0-0AW	SGR-118.0-0A4W	4.686	4.730	5.60	0.295
SGR-119.2-1	SGR-119.2-1A4	SGR-119.2-3FH	SGR-119.2-0AW	SGR-119.2-0A4W	4.731	4.770	5.60	0.295
SGR-120.2-1	SGR-120.2-1A4	SGR-120.2-3FH	SGR-120.2-0AW	SGR-120.2-0A4W	4.771	4.810	5.60	0.295
SGR-121.2-1	SGR-121.2-1A4	SGR-121.2-3FH	SGR-121.2-0AW	SGR-121.2-0A4W	4.811	4.855	5.60	0.295
SGR-122.3-1	SGR-122.3-1A4	SGR-122.3-3FH	SGR-122.3-0AW	SGR-122.3-0A4W	4.856	4.895	5.60	0.295
SGR-123.3-1	SGR-123.3-1A4	SGR-123.3-3FH	SGR-123.3-0AW	SGR-123.3-0A4W	4.896	4.935	6.10	0.295
SGR-124.4-1	SGR-124.4-1A4	SGR-124.4-3FH	SGR-124.4-0AW	SGR-124.4-0A4W	4.936	4.980	6.10	0.295
SGR-125.5-1	SGR-125.5-1A4	SGR-125.5-3FH	SGR-125.5-0AW	SGR-125.5-0A4W	4.981	5.020	6.10	0.295
SGR-126.5-1	SGR-126.5-1A4	SGR-126.5-3FH	SGR-126.5-0AW	SGR-126.5-0A4W	5.021	5.060	6.10	0.295
SGR-127.5-1	SGR-127.5-1A4	SGR-127.5-3FH	SGR-127.5-0AW	SGR-127.5-0A4W	5.061	5.105	6.10	0.295
SGR-128.7-1	SGR-128.7-1A4	SGR-128.7-3FH	SGR-128.7-0AW	SGR-128.7-0A4W	5.106	5.145	6.10	0.295
SGR-129.7-1	SGR-129.7-1A4	SGR-129.7-3FH	SGR-129.7-0AW	SGR-129.7-0A4W	5.146	5.185	6.10	0.295
SGR-130.7-1	SGR-130.7-1A4	SGR-130.7-3FH	SGR-130.7-0AW	SGR-130.7-0A4W	5.186	5.230	6.10	0.295
SGR-131.9-1	SGR-131.9-1A4	SGR-131.9-3FH	SGR-131.9-0AW	SGR-131.9-0A4W	5.231	5.270	6.10	0.295
SGR-132.9-1	SGR-132.9-1A4	SGR-132.9-3FH	SGR-132.9-0AW	SGR-132.9-0A4W	5.271	5.310	6.10	0.295
SGR-133.9-1	SGR-133.9-1A4	SGR-133.9-3FH	SGR-133.9-0AW	SGR-133.9-0A4W	5.311	5.355	6.10	0.295
SGR-135.0-1	SGR-135.0-1A4	SGR-135.0-3FH	SGR-135.0-0AW	SGR-135.0-0A4W	5.356	5.395	6.10	0.295
SGR-136.0-1	SGR-136.0-1A4	SGR-136.0-3FH	SGR-136.0-0AW	SGR-136.0-0A4W	5.396	5.435	6.60	0.295
SGR-137.1-1	SGR-137.1-1A4	SGR-137.1-3FH	SGR-137.1-0AW	SGR-137.1-0A4W	5.436	5.480	6.60	0.295
SGR-138.2-1	SGR-138.2-1A4	SGR-138.2-3FH	SGR-138.2-0AW	SGR-138.2-0A4W	5.481	5.520	6.60	0.295
SGR-139.2-1	SGR-139.2-1A4	SGR-139.2-3FH	SGR-139.2-0AW	SGR-139.2-0A4W	5.521	5.560	6.60	0.295
SGR-140.2-1	SGR-140.2-1A4	SGR-140.2-3FH	SGR-140.2-0AW	SGR-140.2-0A4W	5.561	5.605	6.60	0.295
SGR-141.4-1	SGR-141.4-1A4	SGR-141.4-3FH	SGR-141.4-0AW	SGR-141.4-0A4W	5.606	5.645	6.60	0.295
SGR-142.4-1	SGR-142.4-1A4	SGR-142.4-3FH	SGR-142.4-0AW	SGR-142.4-0A4W	5.646	5.685	6.60	0.295
SGR-143.4-1	SGR-143.4-1A4	SGR-143.4-3FH	SGR-143.4-0AW	SGR-143.4-0A4W	5.686	5.730	6.60	0.295
SGR-144.6-1	SGR-144.6-1A4	SGR-144.6-3FH	SGR-144.6-0AW	SGR-144.6-0A4W	5.731	5.770	6.60	0.295
SGR-145.6-1	SGR-145.6-1A4	SGR-145.6-3FH	SGR-145.6-0AW	SGR-145.6-0A4W	5.771	5.810	6.60	0.295
SGR-146.6-1	SGR-146.6-1A4	SGR-146.6-3FH	SGR-146.6-0AW	SGR-146.6-0A4W	5.811	5.855	6.60	0.295
SGR-147.7-1	SGR-147.7-1A4	SGR-147.7-3FH	SGR-147.7-0AW	SGR-147.7-0A4W	5.856	5.895	6.60	0.295
SGR-148.7-1	SGR-148.7-1A4	SGR-148.7-3FH	SGR-148.7-0AW	SGR-148.7-0A4W	5.896	5.935	7.10	0.295
SGR-149.8-1	SGR-149.8-1A4	SGR-149.8-3FH	SGR-149.8-0AW	SGR-149.8-0A4W	5.936	5.980	7.10	0.295
SGR-150.9-1	SGR-150.9-1A4	SGR-150.9-3FH	SGR-150.9-0AW	SGR-150.9-0A4W	5.981	6.020	7.10	0.295

\*Custom Part-No Return

\*Custom Part-No Return

BEARING CURRENTS

MOTOR GROUNDING

AEGIS® TECHNOLOGY

LOW VOLTAGE MOTORS

MED VOLTAGE MOTORS

DC MOTORS

INSTALL SHAFT PREP

SHAFT VOLTAGE TESTING

SELECT CORRECT SIZE

PARTS LIST

ENGINEERING SPEC



## AEGIS® Shaft Grounding Ring Parts List

## AEGIS® SGR - Press Fit Mounting for Low Voltage Motors to 500 HP

Note: Use PRO Series Rings for Low Voltage Motors Greater than 500 HP and All Medium Voltage Motors

See page 22

Catalog Number	Min.shaft diameter	Max.shaft diameter	SGR OD Tolerance +0/-0.001	Thickness Max	Bore Tolerance +0.001/-0
SGR-6.9-0A6	0.311	0.355	1.580	0.295	1.576
SGR-8.0-0A6	0.356	0.395	1.580	0.295	1.576
SGR-9.0-0A6	0.396	0.435	1.580	0.295	1.576
SGR-10.1-0A6	0.436	0.480	1.580	0.295	1.576
SGR-11.2-0A6	0.481	0.520	1.580	0.295	1.576
SGR-12.2-0A6	0.521	0.560	1.580	0.295	1.576
SGR-13.2-0A6	0.561	0.605	1.580	0.295	1.576
SGR-14.4-0A6	0.606	0.645	1.580	0.295	1.576
SGR-15.4-0A6	0.646	0.685	2.080	0.295	2.076
SGR-16.4-0A6	0.686	0.730	2.080	0.295	2.076
SGR-17.6-0A6	0.731	0.774	2.080	0.295	2.076
SGR-18.7-0A6	0.775	0.815	2.080	0.295	2.076
SGR-19.7-0A6	0.816	0.855	2.080	0.295	2.076
SGR-20.7-0A6	0.856	0.895	2.080	0.295	2.076
SGR-21.7-0A6	0.896	0.935	2.080	0.295	2.076
SGR-22.8-0A6	0.936	0.980	2.080	0.295	2.076
SGR-23.9-0A6	0.981	1.020	2.080	0.295	2.076
SGR-24.9-0A6	1.021	1.060	2.080	0.295	2.076
SGR-25.9-0A6	1.061	1.105	2.080	0.295	2.076
SGR-27.1-0A6	1.106	1.145	2.080	0.295	2.076
SGR-28.1-0A6	1.146	1.185	2.080	0.295	2.076
SGR-29.1-0A6	1.186	1.230	2.080	0.295	2.076
SGR-30.3-0A6	1.231	1.270	2.080	0.295	2.076
SGR-31.3-0A6	1.271	1.310	2.080	0.295	2.076
SGR-32.3-0A6	1.311	1.355	2.080	0.295	2.076
SGR-33.4-0A6	1.356	1.395	2.080	0.295	2.076
SGR-34.4-0A6	1.396	1.435	2.660	0.295	2.656
SGR-35.5-0A6	1.436	1.480	2.660	0.295	2.656
SGR-36.6-0A6	1.481	1.520	2.660	0.295	2.656
SGR-37.6-0A6	1.521	1.560	2.660	0.295	2.656
SGR-38.6-0A6	1.561	1.605	2.660	0.295	2.656
SGR-39.8-0A6	1.606	1.645	2.660	0.295	2.656
SGR-40.8-0A6	1.646	1.685	2.660	0.295	2.656
SGR-41.8-0A6	1.686	1.730	2.660	0.295	2.656
SGR-43.0-0A6	1.731	1.770	2.660	0.295	2.656
SGR-44.0-0A6	1.771	1.810	2.660	0.295	2.656
SGR-45.0-0A6	1.811	1.855	2.660	0.295	2.656
SGR-46.1-0A6	1.856	1.895	2.660	0.295	2.656
SGR-47.1-0A6	1.896	1.935	2.660	0.295	2.656
SGR-48.2-0A6	1.936	1.980	2.660	0.295	2.656
SGR-49.3-0A6	1.981	2.020	2.660	0.295	2.656
SGR-50.3-0A6	2.021	2.060	3.080	0.295	3.076
SGR-51.3-0A6	2.061	2.105	3.080	0.295	3.076
SGR-52.5-0A6	2.106	2.145	3.080	0.295	3.076
SGR-53.5-0A6	2.146	2.185	3.080	0.295	3.076
SGR-54.5-0A6	2.186	2.230	3.080	0.295	3.076
SGR-55.7-0A6	2.231	2.270	3.080	0.295	3.076
SGR-56.7-0A6	2.271	2.310	3.080	0.295	3.076
SGR-57.7-0A6	2.311	2.355	3.080	0.295	3.076
SGR-58.8-0A6	2.356	2.395	3.080	0.295	3.076
SGR-59.8-0A6	2.396	2.435	3.580	0.295	3.576
SGR-60.9-0A6	2.436	2.480	3.580	0.295	3.576
SGR-62.0-0A6	2.481	2.520	3.580	0.295	3.576
SGR-63.0-0A6	2.521	2.560	3.580	0.295	3.576
SGR-64.0-0A6	2.561	2.605	3.580	0.295	3.576
SGR-65.2-0A6	2.606	2.645	3.580	0.295	3.576
SGR-66.2-0A6	2.646	2.685	3.580	0.295	3.576
SGR-67.2-0A6	2.686	2.730	3.580	0.295	3.576
SGR-68.4-0A6	2.731	2.770	3.580	0.295	3.576
SGR-69.4-0A6	2.771	2.810	3.580	0.295	3.576
SGR-70.4-0A6	2.811	2.855	3.580	0.295	3.576
SGR-71.5-0A6	2.856	2.895	3.580	0.295	3.576
SGR-72.5-0A6	2.896	2.935	4.080	0.295	4.076
SGR-73.6-0A6	2.936	2.980	4.080	0.295	4.076
SGR-74.7-0A6	2.981	3.020	4.080	0.295	4.076
SGR-75.7-0A6	3.021	3.060	4.080	0.295	4.076
SGR-76.7-0A6	3.061	3.105	4.080	0.295	4.076
SGR-77.9-0A6	3.106	3.145	4.080	0.295	4.076
SGR-78.9-0A6	3.146	3.185	4.080	0.295	4.076

Custom Part-No Return

Catalog Number	Min.shaft diameter	Max.shaft diameter	SGR OD Tolerance +0/-0.001	Thickness Max	Bore Tolerance +0.001/-0
SGR-79.9-0A6	3.186	3.230	4.080	0.295	4.076
SGR-81.1-0A6	3.231	3.270	4.080	0.295	4.076
SGR-82.1-0A6	3.271	3.310	4.080	0.295	4.076
SGR-83.1-0A6	3.311	3.355	4.080	0.295	4.076
SGR-84.2-0A6	3.356	3.395	4.080	0.295	4.076
SGR-85.2-0A6	3.396	3.435	4.580	0.295	4.576
SGR-86.3-0A6	3.436	3.480	4.580	0.295	4.576
SGR-87.4-0A6	3.481	3.520	4.580	0.295	4.576
SGR-88.4-0A6	3.521	3.560	4.580	0.295	4.576
SGR-89.4-0A6	3.561	3.605	4.580	0.295	4.576
SGR-90.6-0A6	3.606	3.645	4.580	0.295	4.576
SGR-91.6-0A6	3.646	3.685	4.580	0.295	4.576
SGR-92.6-0A6	3.686	3.730	4.580	0.295	4.576
SGR-93.8-0A6	3.731	3.770	4.580	0.295	4.576
SGR-94.8-0A6	3.771	3.810	4.580	0.295	4.576
SGR-95.8-0A6	3.811	3.855	4.580	0.295	4.576
SGR-96.9-0A6	3.856	3.895	4.580	0.295	4.576
SGR-97.9-0A6	3.896	3.935	5.080	0.295	5.076
SGR-99.0-0A6	3.936	3.980	5.080	0.295	5.076
SGR-100.1-0A6	3.981	4.020	5.080	0.295	5.076
SGR-101.1-0A6	4.021	4.060	5.080	0.295	5.076
SGR-102.1-0A6	4.061	4.105	5.080	0.295	5.076
SGR-103.3-0A6	4.106	4.145	5.080	0.295	5.076
SGR-104.3-0A6	4.146	4.185	5.080	0.295	5.076
SGR-105.3-0A6	4.186	4.230	5.080	0.295	5.076
SGR-106.5-0A6	4.231	4.270	5.080	0.295	5.076
SGR-107.5-0A6	4.271	4.310	5.080	0.295	5.076
SGR-108.5-0A6	4.311	4.355	5.080	0.295	5.076
SGR-109.6-0A6	4.356	4.395	5.080	0.295	5.076
SGR-110.6-0A6	4.396	4.435	5.580	0.295	5.576
SGR-111.7-0A6	4.436	4.480	5.580	0.295	5.576
SGR-112.8-0A6	4.481	4.520	5.580	0.295	5.576
SGR-113.8-0A6	4.521	4.560	5.580	0.295	5.576
SGR-114.8-0A6	4.561	4.605	5.580	0.295	5.576
SGR-116.0-0A6	4.606	4.645	5.580	0.295	5.576
SGR-117.0-0A6	4.646	4.685	5.580	0.295	5.576
SGR-118.0-0A6	4.686	4.730	5.580	0.295	5.576
SGR-119.2-0A6	4.731	4.770	5.580	0.295	5.576
SGR-120.2-0A6	4.771	4.810	5.580	0.295	5.576
SGR-121.2-0A6	4.811	4.855	5.580	0.295	5.576
SGR-122.3-0A6	4.856	4.895	5.580	0.295	5.576
SGR-123.3-0A6	4.896	4.935	6.080	0.295	6.076
SGR-124.4-0A6	4.936	4.980	6.080	0.295	6.076
SGR-125.5-0A6	4.981	5.020	6.080	0.295	6.076
SGR-126.5-0A6	5.021	5.060	6.080	0.295	6.076
SGR-127.5-0A6	5.061	5.105	6.080	0.295	6.076
SGR-128.7-0A6	5.106	5.145	6.080	0.295	6.076
SGR-129.7-0A6	5.146	5.185	6.080	0.295	6.076
SGR-130.7-0A6	5.186	5.230	6.080	0.295	6.076
SGR-131.9-0A6	5.231	5.270	6.080	0.295	6.076
SGR-132.9-0A6	5.271	5.310	6.080	0.295	6.076
SGR-133.9-0A6	5.311	5.355	6.080	0.295	6.076
SGR-135.0-0A6	5.356	5.395	6.080	0.295	6.076
SGR-136.0-0A6	5.396	5.435	6.580	0.295	6.576
SGR-137.1-0A6	5.436	5.480	6.580	0.295	6.576
SGR-138.2-0A6	5.481	5.520	6.580	0.295	6.576
SGR-139.2-0A6	5.521	5.560	6.580	0.295	6.576
SGR-140.2-0A6	5.561	5.605	6.580	0.295	6.576
SGR-141.4-0A6	5.606	5.645	6.580	0.295	6.576
SGR-142.4-0A6	5.646	5.685	6.580	0.295	6.576
SGR-143.4-0A6	5.686	5.730	6.580	0.295	6.576
SGR-144.6-0A6	5.731	5.770	6.580	0.295	6.576
SGR-145.6-0A6	5.771	5.810	6.580	0.295	6.576
SGR-146.6-0A6	5.811	5.855	6.580	0.295	6.576
SGR-147.7-0A6	5.856	5.895	6.580	0.295	6.576
SGR-148.7-0A6	5.896	5.935	7.080	0.295	7.076
SGR-149.8-0A6	5.936	5.980	7.080	0.295	7.076
SGR-150.9-0A6	5.981	6.020	7.080	0.295	7.076

Custom Part-No Return



Dimensions in inches

Patented Technology



# AEGIS® uKIT with Universal Mounting NEMA and IEC Motors for Low Voltage Motors to 500 HP



- Kit is designed to avoid any slinger or shaft shoulder. Order based on NEMA or IEC Frame size.
- Install with 3 or 4 brackets depending on motor end bracket design.
- uKIT can be attached to motor with screws/washers provided or with conductive epoxy. AEGIS® EP2400 Conductive Epoxy sold separately.
- See AEGIS® website for bolt hole circle and installation. [www.est-aegis.com/uKIT](http://www.est-aegis.com/uKIT)



AEGIS® EP2400 Conductive Epoxy installation



Solid Ring with 3 brackets

NEMA uKIT - Solid Ring Catalog Number	NEMA uKIT - Split Ring Catalog Number	Motor shaft dia "u"	NEMA Frame
SGR-0.625-UKIT	SGR-0.625-UKIT-1A4	0.625"	56
SGR-0.875-UKIT	SGR-0.875-UKIT-1A4	0.875"	56HZ, 143T, 145T
SGR-1.125-UKIT	SGR-1.125-UKIT-1A4	1.125"	182T, 184T
SGR-1.375-UKIT	SGR-1.375-UKIT-1A4	1.375"	213T, 215T
SGR-1.625-UKIT	SGR-1.625-UKIT-1A4	1.625"	254T, 256T, 284TS, 286TS
SGR-1.875-UKIT	SGR-1.875-UKIT-1A4	1.875"	284T, 286T, 324TS, 326TS, 364TS, 365TS
SGR-2.125-UKIT	SGR-2.125-UKIT-1A4	2.125"	324T, 326T, 404TS, 405TS
SGR-2.375-UKIT	SGR-2.375-UKIT-1A4	2.375"	364T, 365T, 444TS, 445TS, 447TS, 449TS
SGR-2.875-UKIT	SGR-2.875-UKIT-1A4	2.875"	404T, 405T
SGR-3.375-UKIT	SGR-3.375-UKIT-1A4	3.375"	444T, 445T, 447T, 449T
SGR-3.625-UKIT	SGR-3.625-UKIT-1A4	3.625"	
SGR-3.875-UKIT	SGR-3.875-UKIT-1A4	3.875"	
SGR-4.375-UKIT	SGR-4.375-UKIT-1A4	4.375"	
SGR-4.875-UKIT	SGR-4.875-UKIT-1A4	4.875"	

Includes: AEGIS® SGR Bearing Protection Ring, (4) universal brackets of each size - 16 total, (4) 5-40 x 3/8" flat head screws, (4) 6-32 x 3/8" socket head cap screws, (4) #6 split lock washers, (4) #6 flat washers, 5/64" allen wrench, 7/64" allen wrench

IEC uKIT - Solid Ring Catalog Number	IEC uKIT - Split Ring Catalog Number	Motor shaft dia "d"	IEC Frame
SGR-28-UKIT	SGR-28-UKIT-2A4	28mm	IEC 100L, 112M (2, 4, 6, 8 pole)
SGR-38-UKIT	SGR-38-UKIT-2A4	38mm	IEC 132S, 132M (2, 4, 6, 8 pole)
SGR-42-UKIT	SGR-42-UKIT-2A4	42mm	IEC 160M, 160L (2, 4, 6, 8 pole)
SGR-48-UKIT	SGR-48-UKIT-2A4	48mm	IEC 180M, 180L (2, 4, 6, 8 pole)
SGR-55-UKIT	SGR-55-UKIT-2A4	55mm	IEC 200L (2, 4, 6, 8 pole), IEC 225S, 225M (2 pole)
SGR-60-UKIT	SGR-60-UKIT-2A4	60mm	IEC 225S, 225M (4, 6, 8 pole), IEC 250M (2 pole)
SGR-65-UKIT	SGR-65-UKIT-2A4	65mm	IEC 250M (4, 6, 8 pole), IEC 280M, 280S, 315S, 315M, 315L (2 pole)
SGR-70-UKIT	SGR-70-UKIT-2A4	70mm	
SGR-75-UKIT	SGR-75-UKIT-2A4	75mm	IEC 280S, 280M (4, 6, 8 pole), IEC 355M, 355L (2 pole)
SGR-80-UKIT	SGR-80-UKIT-2A4	80mm	IEC 315S, 315M, 315L (4, 6, 8 pole)
SGR-85-UKIT	SGR-85-UKIT-2A4	85mm	
SGR-90-UKIT	SGR-90-UKIT-2A4	90mm	
SGR-95-UKIT	SGR-95-UKIT-2A4	95mm	IEC 335L, 335M, 355L, 355M (4, 6, 8, 10 pole)
SGR-100-UKIT	SGR-100-UKIT-2A4	100mm	
SGR-110-UKIT	SGR-110-UKIT-2A4	110mm	

Includes: AEGIS® SGR Bearing Protection Ring, (4) universal brackets of each size - 16 total, (4) 5-40 x 3/8" flat head screws, (4) M4 x 10 socket head cap screws, (4) M4 split lock washers, (4) M4 flat washers, 5/64" allen wrench, 3mm allen wrench



## AEGIS® Shaft Grounding Ring Parts List

### AEGIS® PRO Series

for Low Voltage Motors Greater than 500 HP, All Medium Voltage Motors and DC Motors over 300 HP



Bolt Through Mounting (4x)

#### AEGIS® PRO Series

AEGIS® PROSL  
AEGIS® PROSLR  
AEGIS® PROMR  
AEGIS® PROMAX

Shaft Diameter 2.5" to 30.00" [63.5mm to 762mm]  
High Current Bearing Protection for Large Motors over 500 hp and Generators (Medium Voltage-greater than 600 volts AC)

Part numbers based on shaft diameter  
To size ring, see page 27  
Drawings available upon request

Solid and Split Ring design  
6 rows of fiber

Includes bolt through mounting hardware  
Ships with CS015 Colloidal Silver Shaft Coating  
Custom brackets available upon request

### AEGIS® WTG



Bolt Through Mounting (4x)

#### AEGIS® WTGSL Wind Turbine Grounding

AEGIS® WTGSL

Shaft Diameter 2.5" to 15.75" [63.5mm to 400mm]  
High Current Bearing Protection for Wind Turbine Generators

Outside Diameter: Shaft Diameter + 1.86" [47.24mm]  
Part numbers based on shaft diameter  
Drawings available upon request

Solid and Split Ring design  
6 rows of fiber

Includes bolt through mounting hardware  
Ships with CS015 Colloidal Silver Shaft Coating  
Custom brackets available upon request



See AEGIS website for  
more details:  
[www.est-aegis.com/WTG](http://www.est-aegis.com/WTG)



Patented Technology

## Optional Mounting Brackets for AEGIS® PRO Series and WTGSL

For AEGIS® PROSL, PROSLR, PROMR, WTGSL



### AEGIS® PRO Brackets

These brackets can be used with the AEGIS®PRO Series and AEGIS® WTGSL

Part Number: <b>BKT-PRO-1</b>	Part Number: <b>BKT-PRO-2</b>
English Hardware	Metric Hardware
(4) Universal brackets	(4) Universal brackets
(4) 3/4 x 1/2" spacers	(4) 19mm x 12.7mm spacers
(4) 3/4 x 1" spacers	(4) 19mm x 25.4mm spacers
(4) 3/4 x 1-1/2" spacers	(4) 19mm x 38.1mm spacers
(4) 5/16-18 x 1.25" SHCS	(4) M8 x 35mm SHCS
(4) 5/16-18 x 1.75" SHCS	(4) M8 x 45mm SHCS
(4) 5/16-18 x 2.25" SHCS	(4) M8 x 60mm SHCS
(4) flat washers	(4) flat washers
(4) lock washers	(4) lock washers

### Custom Brackets/Installation Examples

Contact our Engineering Team for special mounting applications.



Custom Split Mounting Plate with tie bars



Bearing Cap Mounting



Custom Mounting Brackets



## AEGIS® Shaft Grounding Ring Parts List

## AEGIS® Shaft Voltage Tester™



The AEGIS® Shaft Voltage Tester™ kit includes everything you need to start testing motor shaft voltages. At its core is a 2 channel, 100 MHz digital oscilloscope with a 5.7" screen and easy screen capture.

	AEGIS-OSC-9100A	AEGIS-OSC-9100-W2	AEGIS-OSC-9100MB-W2	AEGIS-OSC-9100MB-W2-IC
AEGIS® Shaft Voltage Tester™ Digital Oscilloscope	■	■	■	■
AEGIS® Shaft Voltage Probe™ with Tip Installed	■	■	■	■
Spare 1X/10X Oscilloscope Probe	■	■	■	■
USB Probe Calibration Dongle	■	■	■	■
Multimeter Test Leads	■	■	■	■
Rechargeable/replaceable Battery	■	■	■	■
Power Supply (9V, 4A DC; 120/240 VAC)	■	■	■	■
Compact Carrying Case	■	■	■	■
USB Flash drive, loaded with manual	■	■	■	■
AEGIS® Bearing Protection Handbook	■	■	■	■
Alligator Grounding Clips	1	1	2	2
Spare AEGIS® Shaft Voltage Probe™ Tips			3	3
AEGIS® Shaft Grounding Simulator™			■	■
Probe Holder			■	■
Magnetic Base			■	■
Universal Power Adapter				■
ISO 17025 Calibration				■
Warranty Length	90 days	2 years	2 years	2 years



Catalog Number	Includes:
SVP-KIT-9100MB	3 SVP tips, probe holder with two piece extension rod (total length of probe holder with extension rod is 18 inches), AEGIS® Grounding Simulator with alligator ground clip, and magnetic base.
AEGIS-SVP-510	AEGIS® Shaft Voltage Probe™ PP510 with BNC connector. 1 AEGIS® SVP Tip 1 alligator ground clip
SVP-TIP-9100	3 SVP replacement tips only
BAT-9100	Spare/replacement battery



Patented Technology



# AEGIS® HFGS and Accessories

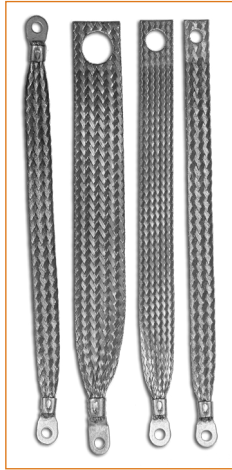

## AEGIS® HFGS High-Frequency Ground Strap Length: 12" and 24"

Catalog Number	Terminations	Fits Frame Sizes:
HFGS-T0410-R0312-12 12" [305mm]	Term 1: Punched hole 0.41" [10mm]	NEMA: 48, 48H, 56, 56H, 143T, 145T, 182T, 184T, 213T, 215T IEC: 80M, 90S, 90L
HFGS-T0410-R0312-24 24" [610mm]	Term 2: Ring terminal for 5/16" or 8 mm screws	
HFGS-T0660-R0312-12 12" [305mm]	Term 1: Punched hole 0.66" [17mm]	NEMA: 254T, 256T, 284T, 284TS, 286T, 286TS, 324T, 324TS, 326T, 326TS, 364T, 364TS, 365T, 365TS IEC: 100S, 100L, 112S, 112M, 132S, 132M, 160S, 160M, 160L, 180S, 180M, 180L
HFGS-T0660-R0312-24 24" [610mm]	Term 2: Ring terminal for 5/16" or 8 mm screws	
HFGS-T0940-R0312-12 12" [305mm]	Term 1: Punched hole 0.94" [24mm]	NEMA: 404T, 404TS, 405T, 405TS, 444T, 444TS, 445T, 445TS, 447T, 447TS, 449T, 449TS IEC: 200S, 200M, 200L, 225S, 225M, 250S, 250M, 280S, 280M
HFGS-T0940-R0312-24 24" [610mm]	Term 2: Ring terminal for 5/16" or 8 mm screws	
HFGS-R0312-R0312-12 12" [305mm]	Term 1: Ring terminal for 5/16" or 8 mm screws	NEMA/IEC: universal terminations
HFGS-R0312-R0312-24 24" [610mm]	Term 2: Ring terminal for 5/16" or 8 mm screws	
Screws included		
Custom lengths and terminations available on request		



## AEGIS® Colloidal Silver Shaft Coating

Catalog Number	Coverage:
CS015	20-25 applications based on a 3" [76mm] shaft diameter
Used to improve the conductivity of the steel shaft surface. Apply to any VFD driven motor shaft prior to installing the AEGIS® Shaft Grounding Ring.	
Note: Shelf life is 6 months. GHS SDS available at <a href="http://www.est-aegis.com">www.est-aegis.com</a>	



## AEGIS® Conductive Epoxy

Catalog Number	Coverage:
EP2400	2-3 applications
Used to install the AEGIS® Shaft Grounding Ring without drilling and tapping into the motor end bell.	
Note: Shelf life is 9 months. GHS SDS available at <a href="http://www.est-aegis.com">www.est-aegis.com</a>	



## Motors Controlled by PWM Drives (VFD) Electrical Bearing Damage Protection

### Engineering Specification:

Construction Specification Institute Section 23 05 13

MOTORS

23 05

#### 2.1 MOTORS

##### A. General Requirements – Shaft Grounding:

1. All motors operated on variable frequency drives shall be equipped with a maintenance free, conductive micro fiber, shaft grounding ring with a minimum of two rows of circumferential micro fibers to discharge damaging shaft voltages away from the bearings to ground.
2. Application Note: Motors up to 100HP shall be provided with one shaft grounding ring installed either on the drive end or non-drive end. Motors over 100HP shall be provided with an insulated bearing on the non-drive end and a shaft grounding ring on the drive end of the motor. Grounding rings shall be provided and installed by the motor manufacturer or contractor and shall be installed in accordance with the manufacturer’s recommendations.

##### B. General Requirements – High-Frequency Bonding:

1. All motors operated on variable frequency drives shall be bonded from the motor foot to system ground with a high frequency ground strap made of flat braided, tinned copper with terminations to accommodate motor foot and system ground connection.
2. Application Note: Proper grounding of motor frame for all inverter-driven induction motors

##### References:

- a. ABB Technical Guide No.5
- b. Allen Bradley Publication 1770-4.1 Application Data, Industrial Automation Wiring and Grounding Guidelines

Recommended parts: AEGIS® Shaft Grounding Ring  
AEGIS® High Frequency Ground Strap

Recommended source: Electro Static Technology-ITW  
Manufacturer of AEGIS® Shaft Grounding Ring  
Ph: 207.998.5140 | sales@est-aegis.com | www.est-aegis.com

Detail sheets for the AEGIS® Ring and the High Frequency Ground Strap can be downloaded at [www.est-aegis.com/specs.php](http://www.est-aegis.com/specs.php)

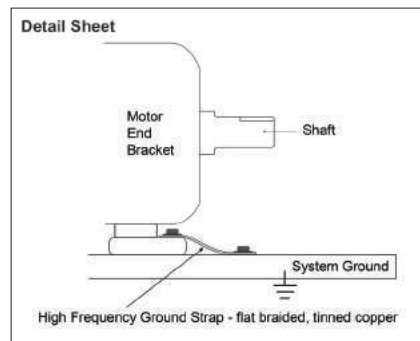
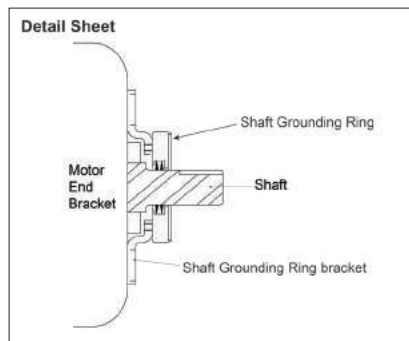

WARRANTY: Units are guaranteed for one year from date of purchase against defective materials and workmanship. Replacement will be made except for defects caused by abnormal use or mishandling. All statements and technical information contained herein, or presented by the manufacturer or his representative are rendered in good faith. User must assume responsibility to determine suitability of the product for intended use. The manufacturer shall not be liable for any injury, loss or damage, direct or consequential arising out of the use, or attempt to use the product.

The following patents apply: 8199453, 8169766, 7193836, 7136271, 7528513, 7339777, and other patents pending.



Patented Technology



## Register your motor for the AEGIS 2-Year Warranty Against Bearing Fluting Damage



Electro Static Technology (EST, AEGIS®) guarantees that AC induction motor bearings will not fail from electrical fluting damage when AEGIS® Shaft Grounding Rings have been installed with new bearings in accordance with EST's recommended best practices, as published in the AEGIS® Bearing Protection Handbook (current edition).

- The AC induction motor must meet the conditions listed below and new bearings must be installed at the time of AEGIS® Ring installation for the warranty to be approved.
- For repaired motors or for field installations: Upon registration and approval the warranty shall be for 2 years from the installation date of the new motor bearings and AEGIS Ring.
- For new motors with AEGIS® rings installed by the motor manufacturer: Upon registration the warranty shall be for a 2 year period after the motor manufacturer's bearing warranty ends.
- If electrically induced bearing fluting damage occurs, EST will pay the current Vaughn's National Average Price for "Furnish/Install 2 Standard Ball Bearings" and will supply a new shaft grounding ring (SGR or PRO as appropriate) and CS015. The warranty shall apply to any AC induction motor whether new or repaired which conforms to the AEGIS® Bearing Protection Handbook's best practices.

### Conditions:

1. For All Motors: New bearings MUST be installed at the time of AEGIS® Ring installation.
2. All Motors: For this warranty to be valid, the owner must register the motor within 30 days of receipt, by filling out and submitting the information at [www.est-aegis.com/warranty](http://www.est-aegis.com/warranty).
3. For AC Induction motors up to 100 HP: The warranty shall apply when AEGIS® Rings have been installed on the motor per the AEGIS® Bearing Protection Handbook's best practices.
4. AC Induction motors greater than 100 HP: The warranty shall apply when AEGIS® Rings and insulated bearings/insulation have been installed on the motor per the AEGIS® Bearing Protection Handbook's best practices.
5. AC Induction motors greater than 500 HP and ANY motor with supply voltage of greater than 600 VAC (medium/high voltage): The warranty shall only apply when AEGIS® PRO Series Rings and insulated bearings/insulation have been installed on the motor per the AEGIS® Bearing Protection Handbook's best practices.
6. The best practices shall apply per the current edition of the AEGIS® Bearing Protection Handbook at the time of installation. The current best practices can be found here.
7. Selection of the applicable ring (AEGIS® SGR or PRO Series) must conform to the requirements in the AEGIS® Bearing Protection Handbook.
8. The owner of the motor must verify that the installation of AEGIS® Rings and bearing insulation, if applicable, was per the AEGIS® Bearing Protection Handbook's best practices in order to receive approval for the warranty.
9. EST shall retain the sole authority to issue and approve the warranty for any application.
10. The warranty shall be activated and conferred to the motor owner upon the issuance by EST of an email or certificate confirming warranty acceptance.





# Award Winning Technology



**GOLDEN  
MOUSETRAP  
AWARDS**  
2017 WINNER



Plant Engineering  
**PRODUCT  
of the YEAR**  
Winner  
2013



CONSULTING - SPECIFYING  
**engineer.**  
2011  
**PRODUCT  
OF THE YEAR** Gold



**D** 2010  
DEALER DESIGN  
AWARDS  
the NEWS | **SILVER**



CONSULTING - SPECIFYING  
**engineer.**  
2009  
**PRODUCT  
OF THE YEAR** Finalist

**Electro  
Static  
Technology™**  
An ITW Company

31 Winterbrook Road  
Mechanic Falls ME 04256 USA  
Toll Free: 1-866-738-1857  
Ph: 207-998-5140  
Email: [sales@est-aegis.com](mailto:sales@est-aegis.com)  
[www.est-aegis.com](http://www.est-aegis.com)

ISBN 978-0-9905745-4-5



9 780990 574545