



BEAVER ELECTRICAL MACHINERY
 7440 LOWLAND DRIVE, BURNABY, BC, CANADA
 TEL: (604) 431-5000 FAX: (604) 431-5066
 www.beaverelectrical.com

SER SERIES

**1 PHASE ISOLATION TRANSFORMER
 TYPE: EPOXY ENCAPSULATED**

CAT. NO.: SER2FHK-G8C
 KVA: 2
 HIGH VOLT: 120/208/240
 LOW VOLT: 120/240
 PHASE: 1
 FREQ: 60 HZ
 WEIGHT: 29 LBS
 INSUL. CLASS: 200°C
 TEMP. RISE: 135°C
 IMPEDANCE: 3.0-4.0%
 WINDING: COPPER
 ENCLOSURE: NEMA Type 3R
 APPROVALS: UL, CSA

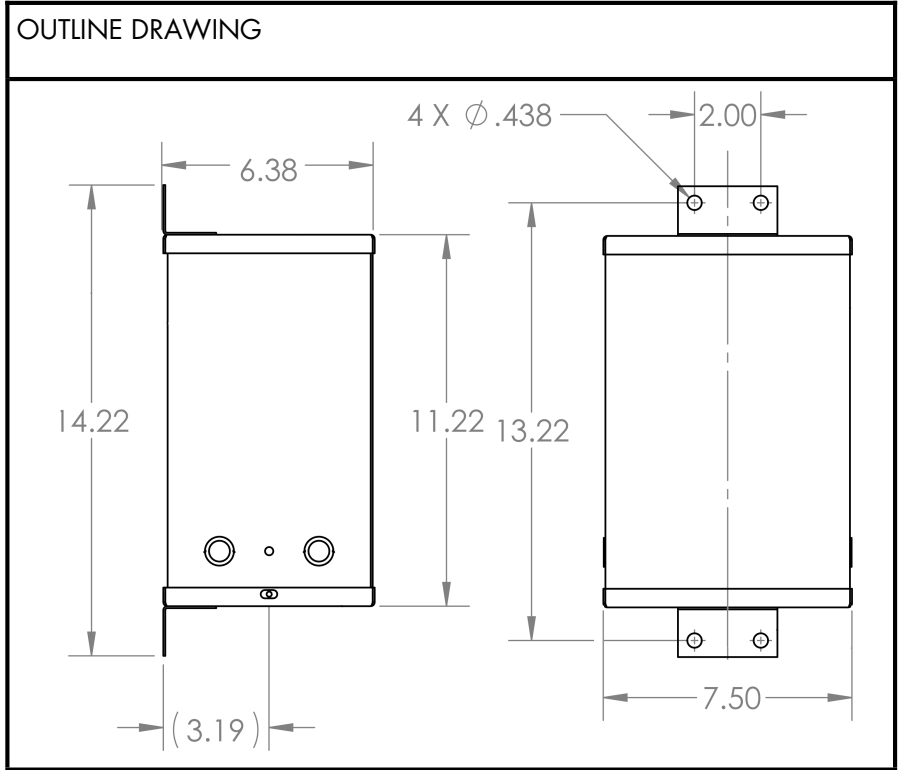

WIRING AND CONNECTION DIAGRAM

HI VOLT	INTERCONNECT	PRI LINE CONN	LOW VOLT	INTERCONNECT	SEC LINE CONN
120		H1-H2	240	X2 TO X3	X1-X4
208		H1-H3	120/240	X2 TO X3	X1-X2-X4
240		H1-H4	120	X1 TO X3 X2 TO X4	X1-X4

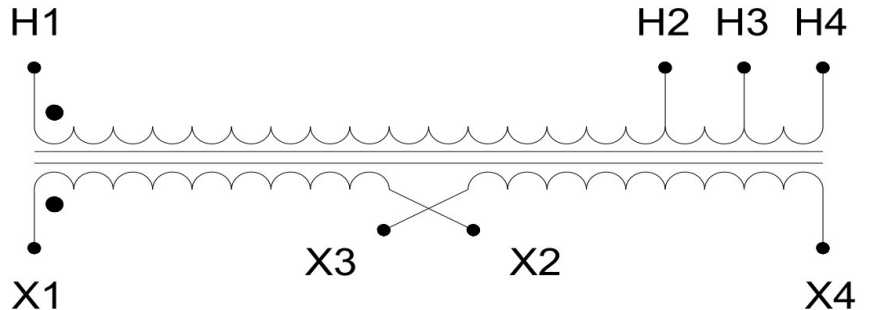

NOTE: Specifications and dimensions subject to change without notice