



BEAVER ELECTRICAL MACHINERY
 7440 LOWLAND DRIVE, BURNABY, BC, CANADA
 TEL: (604) 431-5000 TF: 1-800-663-6505
 www.beaverelectrical.com - sales@beaverelectrical.com

**EER SERIES
 SPECIFICATION SHEET**

**1 PHASE AUTOTRANSFORMER
 TYPE: ENCAPSULATED
 WALL MOUNTABLE**

CAT. NO.: EER3KH8C
 KVA: 3
 VOLT: 240/230/220/208
 PHASE: 1
 FREQ: 60 HZ
 WEIGHT: 8.3 LBS
 INSUL. CLASS: 180°C
 TEMP. RISE: 115°C
 WDG MAT'L: Copper
 ENCLOSURE: TYPE 3R
 APPROVALS: UL, CUL

OUTLINE DRAWING

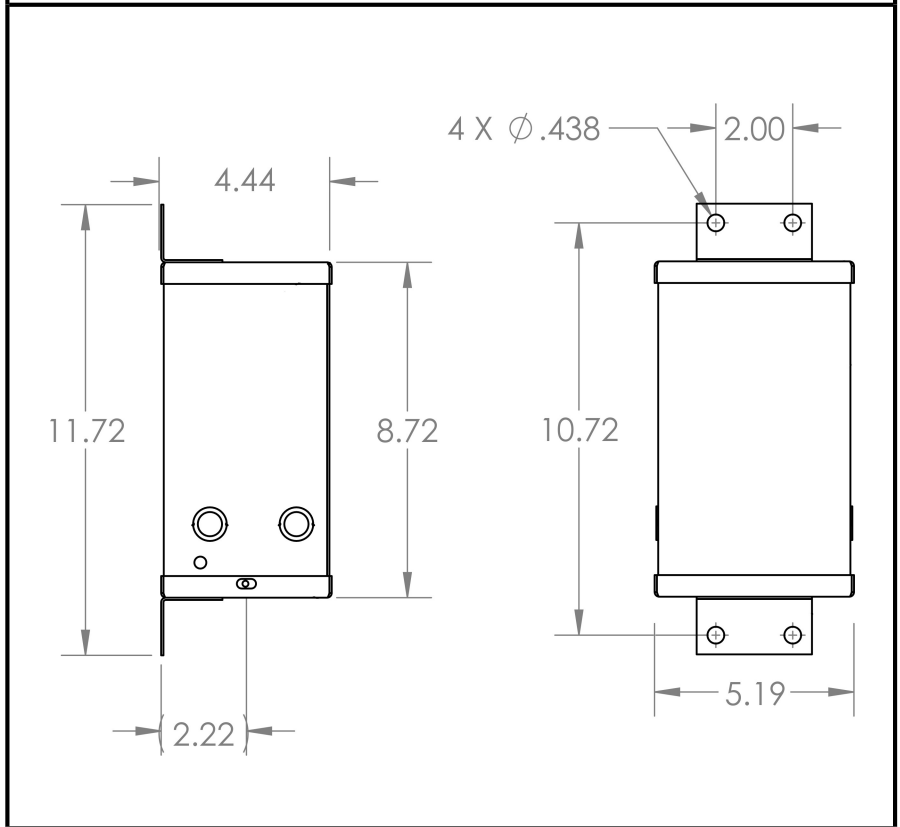

WIRING AND CONNECTION DIAGRAM

VOLT		LINE CONN
240		1-5
230		1-4
220		1-3
208		1-2

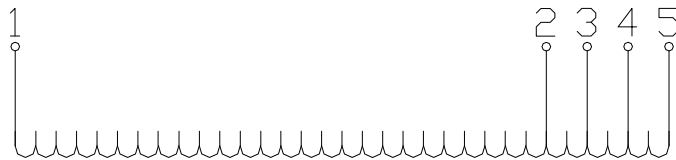

NOTE: Specifications and dimensions subject to change without notice