



E510

**TECO**   **Westinghouse**

# E510

## NEMA 4/ 12 AC Drive\*



1-20 HP (230V)  
1-25 HP (460V)  
\*Indoor Duty Only

Pair this drive with our  
Washdown Duty motors



# Control Mode Application & Selection Guide

The E510 NEMA 4/ 12 Variable Speed Drive is a versatile and compact AC Drive that can control today's demanding motor driven applications in a cost effective manner. Further, the E510 provides an ideal solution for fans, pumps, mixing, and conveyors installed in non-ideal environments.

- Areas in contact with corrosive solutions
- Processing areas that require periodic washdown:
  - Food
  - Beverage
  - Pharmaceuticals
- Corrosive, dusty, humid, or other dirty environments

## FEATURES & HIGHLIGHTS

- Power Range:
  - 230V, 1Ø (0.5 to 3 HP)
  - 230V, 3Ø (1 to 15 HP)
  - 460V, 3Ø (1 to 25 HP)
- Parameters grouped by function
- Built-in PLC Functionality
- PID Process Control Loop
  - Sleep Mode
  - 0-10VDC or 4-20mA Feedback
  - Loss of feedback or tracking detection
- Built-in Modbus Protocol (RJ45 Interface)
- 5 Digit operator's keypad
  - Scalable Display
  - Programming parameters
  - Diagnostics monitoring
- Built-in Disconnect and Speed Pot on selected models
  - 230V, 1Ø (0.5 to 3 HP)
  - 460V, 3Ø (1 to 15 HP)
- Digital and Analog Inputs and outputs have extremely fast (~4 msec) update time
- Auto Run Mode (cyclic operation)
- Power loss ride through
- Automatic Voltage Regulation (AVR)
  - Stabilizes output voltage against fluctuating input voltage



## SPECIFICATIONS

<b>Control Mode</b>	V/Hz, Sensorless Vector (SLV)
<b>Frequency Range</b>	0-599Hz
<b>Frequency Accuracy</b>	Digital Input .01Hz Analog input: 0.1%
<b>Speed Control</b>	50:1
<b>Starting Torque</b>	150%/1Hz (SLV)
<b>Overload Tolerance Rated Output Current</b>	150%/1minute
<b>Frequency Settings</b>	<ul style="list-style-type: none"> <li>• Frequency setting with ^, v keys</li> <li>• Potentiometer on front cover</li> <li>• External input terminals                             <ul style="list-style-type: none"> <li>- AI1 (0-10VDC)</li> <li>- AI2 (0/4-20mA)</li> </ul> </li> <li>• Multi-function Input</li> <li>• (Up/Down)</li> <li>• Pulse input</li> </ul>
<b>Acceleration Settings</b>	<ul style="list-style-type: none"> <li>• Two sets of acceleration and deceleration times</li> <li>• Jog acceleration and deceleration settings (0-3600 sec)</li> </ul>
<b>Voltage/Frequency Characteristics</b>	<ul style="list-style-type: none"> <li>• Qty 18 preset V/Hz patterns plus user settable V/F pattern</li> <li>• Adjustable voltage (torque) boost</li> </ul>
<b>Control Features</b>	<ul style="list-style-type: none"> <li>• 1-16kHz Carrier frequency (adjustable)</li> <li>• Acceleration/Deceleration ramps with S curves</li> <li>• Sensorless Vector mode with auto tuning</li> <li>• DC Injection braking</li> </ul>
<b>Input Voltage Range</b>	200-240VAC +10%, -15% 380-480VAC +10%, -15%

## I/O FEATURES

<b>Digital Inputs</b>	<ul style="list-style-type: none"> <li>• Qty 6 configurable</li> <li>• Over 25 available selections</li> <li>• Assign each as normally open or normally closed</li> <li>• 24V power supply</li> <li>• Pulse input</li> </ul>
<b>Digital Outputs</b>	<ul style="list-style-type: none"> <li>• Qty 2 relay outputs</li> <li>• Over 20 available selections</li> <li>• Assign each as normally open or normally closed</li> </ul>
<b>Analog Inputs</b>	<ul style="list-style-type: none"> <li>• Qty 2 analog input channels                             <ul style="list-style-type: none"> <li>- 1 at 0-10VDC</li> <li>- 1 at 4-20mA</li> </ul> </li> <li>• Adjustable gain and bias on each channel</li> </ul>
<b>Analog Outputs</b>	<ul style="list-style-type: none"> <li>• 0-10VDC</li> <li>• 5 available configurations                             <ul style="list-style-type: none"> <li>- Output Frequency</li> <li>- Set Frequency</li> <li>- Output Current</li> <li>- Output Voltage</li> <li>- DC Bus Voltage</li> </ul> </li> <li>• Adjustable gain and bias</li> </ul>
<b>Safety Input</b>	Dedicated safety input (factory jumpered)

## PROTECTION FEATURES

<b>Overload Stall Prevention</b>	Up to 150%, 1 minute on acceleration, deceleration and constant speed
<b>Overcurrent</b>	Instantaneous above 200%
<b>DC BUS Overvoltage</b>	230V input: >410VDC 460V input: >810VDC
<b>DC BUS Undervoltage</b>	230V input: <190 VDC 460V input: <380 VDC
<b>Other protection</b>	Ground Fault, Phase Loss, Overtemperature, Loss of PID Feedback External Fault Setting, Fire Mode

## ENVIRONMENTAL FEATURES

<b>Operating Temperature</b>	-10~+50°C
<b>Storage Temperature</b>	-20~+70°C
<b>Humidity</b>	95% RH or less (non-condensing)
<b>Vibration/ Shock</b>	<ul style="list-style-type: none"> <li>• 20 HP or less; 1g (32.2 ft/sec<sup>2</sup>)</li> <li>• 20-25 HP; 0.6g (19.3 ft/sec<sup>2</sup>)</li> </ul>
<b>Certification</b>	Complies with IEC 60018-2-78, UL, cUL, CE, & RoHS

# Convenient Mounting & Design



\* Available on models with suffix "FN4S-U"

# Integral Intelligent LED Keypad

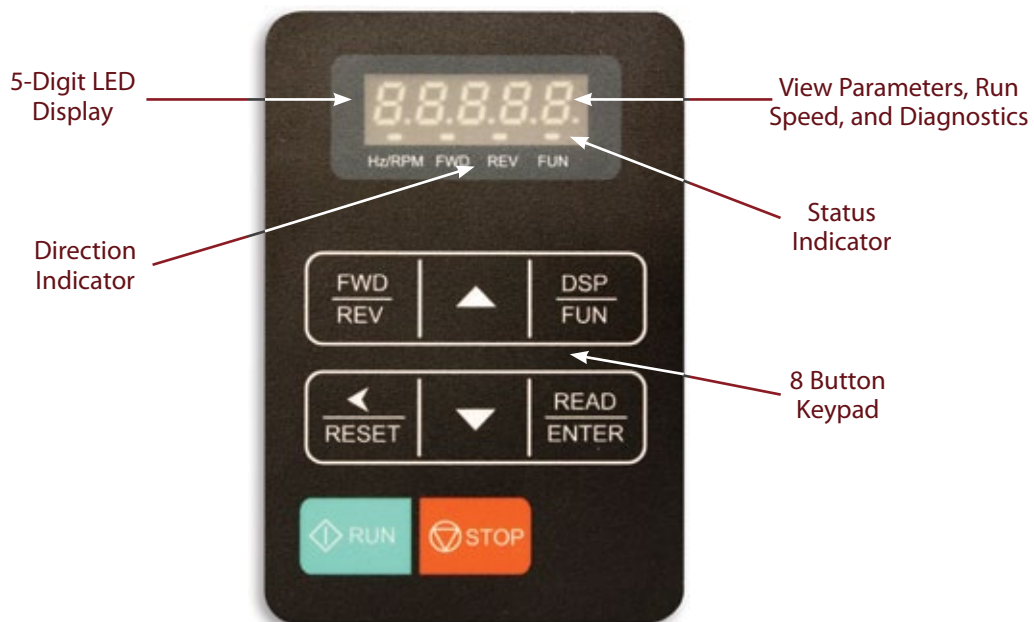

# Connection Diagram

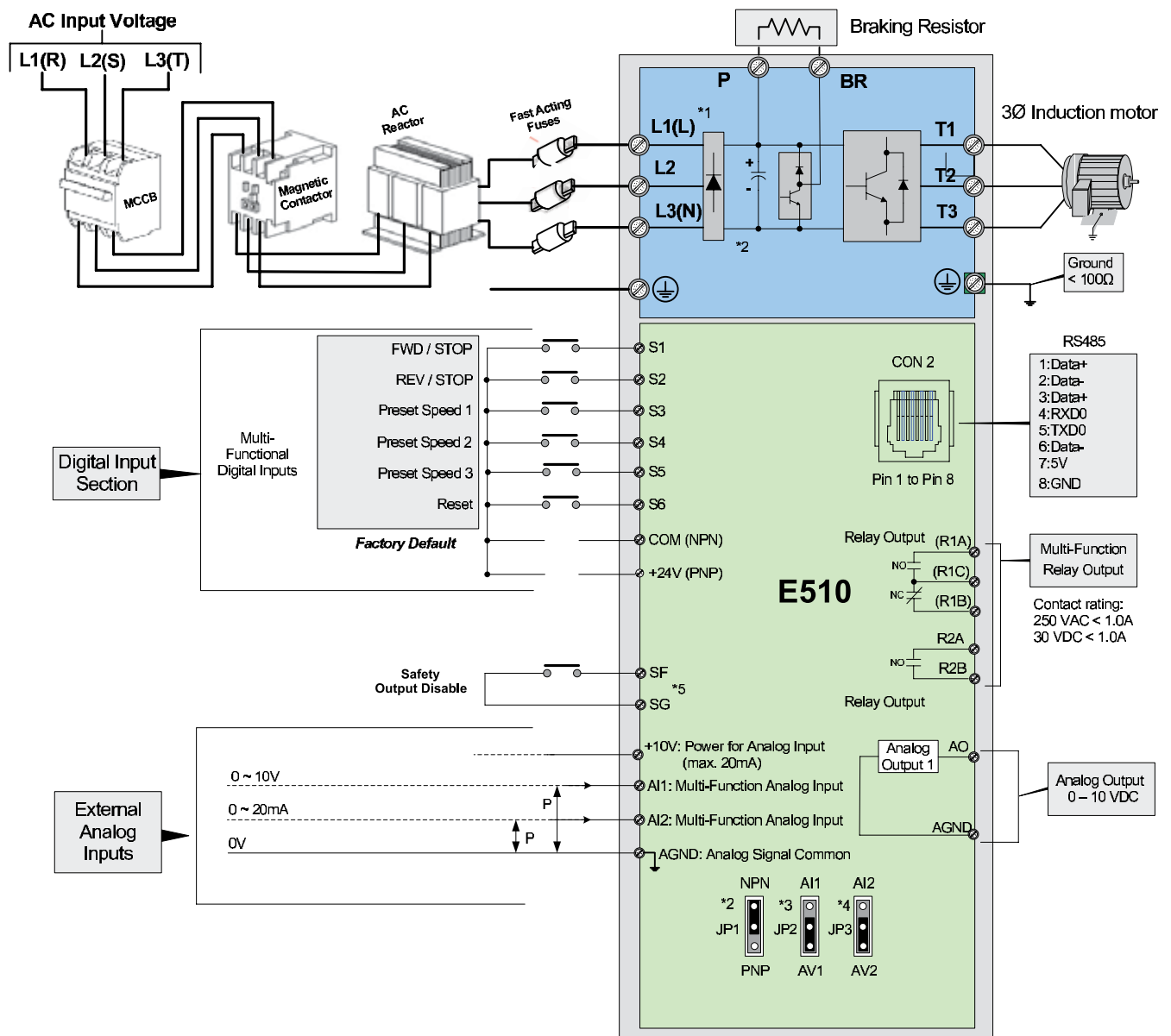

## Notes:

- \*1: Use L1 (L) and L3 (N) for single-phase input
- \*2: Use jumper JP1 to select between Sink (NPN, with 24VG common) or Source (PNP, with +24V common) for multi-function digital input terminals S1~S6.
- \*3: Use jumper JP2 to switch between voltage and current input for Multi-function analog input 1 (AI1).
- \*4: Use jumper JP3 to switch between voltage and current input for Multi-function analog input 1 (AI2).
- \*5: Run Permissive input SF and SG is a normally open input. This input should be closed to enable the inverter output. To activate this input place a jumper wire between SF and SG.

## Control Circuit Terminal

R2A	R2B	COM	S1	S3	S5	SF	24V	AI1	AI2
R1A	R1B	R1C	S2	S4	S6	SG	AGND	10V	AO

# Control Circuit Terminal Description

TYPE	TERMINAL	TERMINAL FUNCTION	SIGNAL LEVEL
<b>Digital Input Signals</b>	S1	Forward–Stop (Preset), Multi-function input terminal	24 VDC, 8mA, optical coupling isolation (Max voltage 30VDC, input impedance 3.3kΩ)
	S2	Reverse–Stop (Preset), Multi-function input terminal	
	S3	Preset Speed1 (5-02), Multi-function input terminal	
	S4	Preset Speed2 (5-03), Multi-function input terminal	
	S5	Preset Speed3 (5-04), Multi-function input terminal	
	S6	Fault reset input (5-05), Multi-function input terminal	
<b>Relay Outputs</b>	R1A	NO (Normally Open)	250VAC/1A(30VDC/1A)
	R1B	NC (Normally Closed)	
	R1C	COMMON	
	R2A	NO (Normally Open)	
	R2B	NO (Normally Open)	
<b>Power Supply</b>	COM	Digital Signal Common Terminal (JP1 NPN position)	±15%, Max output current 60mA
	24V	Digital Signal Common Terminal (JP1 PNP position)	
<b>Analog Input Signals</b>	10V	Built-in power for external speed potentiometer	10V (Max current: 20mA)
	AI1	Multi-functional analog input: JP2 selects voltage or current input Voltage: JP2 in AV1 position Current: JP2 in AI1 position	0~10VDC, 0/4~20mA (Input impedance: 153KΩ)
	AI2	Multi-functional analog input: JP3 selects voltage or current input Voltage: JP3 in AV1 position Current: JP3 in AI1 position	0~10VDC, 0/4~20mA (Input impedance: 153KΩ)
	AGND	Analog common terminal	—
		Shielding wire connecting terminal (The earth)	—
<b>Analog Output Signal</b>	AO	Multi-functional analog output terminal	0~10V, (Max current: 2mA)
	AGND	Analog common terminal	—
<b>Safety Switch</b>	SF	Terminal SF is for output disable	—
	SG		

# Models & Ratings

## Models with Keypad, Padlockable Disconnect Switch, and Potentiometer on Front Cover

### 230V 1-Phase Input/ 3-Phase Output

MODEL NO.	HP	DRIVE AMPS	DIMENSIONS (Inches)			APPROX. WT. (lbs.)
	CONSTANT TORQUE	CONSTANT TORQUE	HEIGHT	WIDTH	DEPTH	
†E510-2P5-H1FN4S-U	0.5	2.6	9.79	5.94	7.87	6.3
†E510-201-H1FN4S-U	1	4.3	9.79	5.94	7.87	6.3
†E510-202-H1FN4S-U	2	7.5	13.19	7.80	9.26	13.2
†E510-203-H1FN4S-U	3	10.5	13.19	7.80	9.26	13.2

### 460V 3-Phase Input/ 3-Phase Output

MODEL NO.	HP	DRIVE AMPS	DIMENSIONS (Inches)			APPROX. WT. (lbs.)
	CONSTANT TORQUE	CONSTANT TORQUE	HEIGHT	WIDTH	DEPTH	
E510-401-H3FN4S-U	1	2.3	9.79	5.94	7.87	6.3
E510-402-H3FN4S-U	2	3.8	9.79	5.94	7.87	6.3
E510-403-H3FN4S-U	3	5.2	13.19	7.80	9.26	13.2
E510-405-H3FN4S-U	5	8.8	13.19	7.80	9.26	13.2
E510-408-H3FN4S-U	7.5	13	18.11	8.77	10.37	28.0
E510-410-H3FN4S-U	10	17.5	18.11	8.77	10.37	28.0
E510-415-H3FN4S-U	15	25	18.11	8.77	10.37	28.0



## Models with Keypad Only on Front Cover

### 230V 3-Phase Input/ 3-Phase Output

MODEL NO.	HP	DRIVE AMPS	DIMENSIONS (Inches)			APPROX. WT. (lbs.)
	CONSTANT TORQUE	CONSTANT TORQUE	HEIGHT	WIDTH	DEPTH	
*E510-2P5-HN4R-U	0.5	2.6	9.79	5.94	7.87	6.3
*E510-201-HN4R-U	1	4.5	9.79	5.94	7.87	6.3
*E510-202-HN4R-U	2	7.5	13.19	7.80	9.26	13.2
*E510-203-HN4R-U	3	10.5	13.19	7.80	9.26	13.2
E510-205-H3N4-U	5	17.5	13.19	7.80	8.60	13.2
E510-208-H3N4-U	8	26.0	18.11	8.77	9.71	28.0
E510-210-H3N4-U	10	35.0	18.11	8.77	9.71	28.0
E510-215-H3N4-U	15	48.0	18.11	8.77	9.71	28.0
E510-220-H3N4-U	20	64.0	18.11	8.77	9.71	28.0



### 460V 3-Phase Input/ 3-Phase Output

MODEL NO.	HP	DRIVE AMPS	DIMENSIONS (Inches)			APPROX. WT. (lbs.)
	CONSTANT TORQUE	CONSTANT TORQUE	HEIGHT	WIDTH	DEPTH	
E510-401-H3N4-U	1	2.3	9.79	5.94	7.20	6.3
E510-402-H3N4-U	2	3.8	9.79	5.94	7.20	6.3
E510-403-H3N4-U	3	5.2	13.19	7.80	8.60	13.2
E510-405-H3N4-U	5	8.8	13.19	7.80	8.60	13.2
E510-408-H3N4-U	7.5	13.0	18.11	8.77	9.71	28.0
E510-410-H3N4-U	10	17.5	18.11	8.77	9.71	28.0
E510-415-H3N4-U	15	25.0	18.11	8.77	9.71	28.0
E510-420-H3N4-U	20	32.0	18.11	8.77	9.71	28.0
E510-425-H3N4-U	25	40.0	18.11	8.77	9.71	28.0



## E510 Options

OPTION PART NO.	DESCRIPTION
JN5-CM-PDP	PROFIBUS communication interface module
JN5-CM-USB	USB cable to connect PC
JN5-CU	Copy unit

\* Can supply either single or 3-phase 230V input; also includes speed pot mounted on front cover.

† Single phase input only

# Stainless Steel Washdown Motors

The stainless steel washdown motor is a complementary product for the E510 Drive and the perfect solution for any application where the motor will be subjected to high pressure spray down.

## Features:

- 1/2 - 10 HP
- 3600, 1800 RPM
- Speed Ranges: 10:1 VT, 4:1 CT
- Grounding terminal inside main box
- Steel frame, end brackets, and hardware
- Designed for 3300 ft. elevation
- Designed for 40°C ambient temperature
- Class B Temperature Rise
- Etched nameplate on the stainless steel frame
- NEMA Design B Torques
- 9 leads, with solderless lug terminals
- EISA compliant with the NEMA Premium efficiencies
- Department of energy efficiency certificate #CC002A
- Designed for 40°C Ambient Temperature
- 60 Hz - 2300/460V (Usable on 208V), 50 Hz - 190/380V data is also provided (1.0 service factor)
- 36 month warranty from date of manufacture (36 months from date of sale when ordering an E510 at the same time)
- Totally enclosed fan cooled (IP56)
- Foot mounted C-Flange and round body (footless) C-Face available
- Inverter duty magnet wire capable of withstanding voltage spikes of up to 2200V
- Stainless steel oversized main conduit box mounted at F-3 location
- SUS304 stainless steel shaft with keyway and key
- Class F insulation with phenolic alkyd resin varnish - 2 dips and bakes
- Contact lip type seal on both drive end and opposite drive end
- 2 drain holes on bottom of frame and on one in C-Flange
- Aluminum die cast squirrel cage rotor construction
- Double sealed bearings pre-packed with MULTEMP SRL grease



## Models and Ratings

CATALOG NO.		HP	RPM	FRAME	FL EFF (%)	FL PF (%)	FL AMPS (460V)
FOOTED C-FACE	ROUND BODY C-FACE						
WP0/52C	WPV0/52C	1/2	3600	A56C	72.0	82.0	1.6
WP0/54C	WPV0/54C	1/2	1800	A56C	74.0	72.5	1.8
WP0/72C	WPV0/72C	3/4	3600	A56C	75.5	82.0	2.3
WP0/74C	WPV0/74C	3/4	1800	A56C	75.5	74.0	2.5
WFP0012C	~	1	3600	A56C	77.0	90.0	2.8
WP0012C	WPV0012C	1	3600	143TC	77.0	90.0	2.8
WFP0014C	WVV0014C	1	1800	B56C	85.5	70.0	3.2
WP0014C	WPV0014C	1	1800	143TC	85.5	70.0	3.2
WFP1/52C	~	1.5	3600	B56C	84.0	90.0	4.0
WP1/52C	WPV1/52C	1.5	3600	143TC	84.0	90.0	4.0
WFP1/54C	~	1.5	1800	C56C	86.5	73.0	4.4
WP1/54C	WPV1/54C	1.5	1800	145TC	86.5	73.0	4.4
WFP0022C	~	2	3600	C56C	85.5	91.0	4.8
WP0022C	WPV0022C	2	3600	145TC	85.5	91.0	4.8
WFP0024C	~	2	1800	C56C	86.5	75.0	6.0
WP0024C	WPV0024C	2	1800	145TC	86.5	75.0	6.0
WP0032C	WPV0032C	3	3600	182TC	86.5	88.0	7.4
WP0034C	WPV0034C	3	1800	182TC	89.5	78.0	8.0
WP0052C	WPV0052C	5	3600	184TC	88.5	91.0	12.2
WP0054C	WPV0054C	5	1800	184TC	89.5	85.0	12.5
WP7/52C	WPV7/52C	7.5	3600	213TC	89.5	85.0	19.0
WP7/54C	WPV7/54C	7.5	1800	213TC	91.7	82.0	18.6
WP0102C	WPV0102C	10	3600	215TC	90.2	87.0	24.4
WP0104C	WPV0104C	10	1800	215TC	91.7	84.0	24.4

Precautions should be taken to eliminate or reduce shaft currents that may be imposed on the motor by the VFD as stated per NEMA MG1 Part 30.

## L510 AC DRIVE



- 1/4 - 3HP, 115/230/460V (Chassis Style, IP20)
- Single to Three Phase Conversion Available
- V/Hz with Auto-Torque Boost, Sensorless Vector
- Assignable Digital Inputs and Outputs
- PID Control and Multi Speed Control
- 5 Digit LED Operator Keypad with Built-in Speed POT
- Built-in Modbus and BACnet Protocols

## E510 AC DRIVE



- 1/2 - 25HP 230/460V (Indoors NEMA 4 Enclosure)
- V/Hz, Sensorless Vector
- Conformal Coated Circuit Boards
- Auto Run Cycle
- PID Control, PLC Functionality, and Multi Speed Control
- 5 Digit LED Operator Keypad
- Built-in Modbus Communication

## A510 AC DRIVE



- 1 - 250HP (CT) 230/460/575/690V (NEMA 1 / Open Chassis)
- V/Hz, Sensorless Vector, Encoder Feedback
- LCD Keypad with Copy Capabilities
- PID Control and PLC Ladder Logic Control
- Advanced Regenerative Load Handling
- Configurable Digital Inputs and Outputs
- Auto-tune Function
- Built-in Modbus Communication

## F510 AC DRIVE



- 1 - 250 HP (VT), 230/460V (NEMA 1/ Open Chassis)
- Variable Torque Rated, (Pumps/Fans)
- V/Hz, Sensorless Vector
- Master / Follower Control
- PID Control and PLC Ladder Logic Control
- Standard LCD Keypad with Real Time Clock and Copy Capabilities
- Built-in Modbus, Metasys, or Bacnet Protocols

## SP2000 AC DRIVE



- 5 - 1000HP 460/575V (Open Chassis)
- V/Hz, Sensorless Vector, Closed Loop Control
- Auto-tune Function
- Built-in Brake Transistor (up to 200HP)
- PID with Sleep Mode
- 8 Digital Inputs, 2 Analog Inputs
- 3 Analog Outputs, Programmable Relay Outputs

## SOFT STARTERS ( LV / MV )

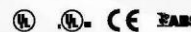

- 230V/460V/575V/2300V - 13.8KV
- Available Open Chassis or with Complete Panel Option
- Built-in Motor Protection
- Built-in Bypass
- ATL Starting Capabilities
- LED Keypad
- Custom Engineered Packages Available
- (MV) ABS Approved

## CUSTOM PACKAGED DRIVE SYSTEMS



- Custom Built to Your Needs
- Industry Specific Applications
- NEMA 1, NEMA 3R, NEMA 12 (Or Other)

## FILTER SOLUTIONS

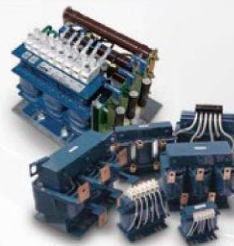

- Line and Load Reactors
- DV/DT Filter
- Sine Wave Filters
- Matrix Filters (IEEE 519)
- EMI Filters

### WEST

1-800-661-4023  
**Tony MacDonald**  
 Account Manager  
 780-394-1591



MOTORS (CANADA) INC.

[tecowestinghouse.ca](http://tecowestinghouse.ca)  
 E-mail: [sales@tecowestinghouse.ca](mailto:sales@tecowestinghouse.ca)

Contact Your Local TECO-Westinghouse Office Today for Quote and Availability

### EAST

1-800-268-4770

Printed in Canada 03/18