



BEAVER ELECTRICAL MACHINERY
 7440 LOWLAND DRIVE, BURNABY, BC, CANADA
 TEL: (604) 431-5000 FAX: (604) 431-5066
 www.beaverelectrical.com

**AVR SERIES
 SPECIFICATION SHEET**

**3 PHASE TRANSFORMER
 TYPE: DRY TYPE
 FLOOR OR WALL MOUNT**

CAT. NO.: AVR6TSKH4C
 KVA: 6
 VOLT: 600Y/480Y/240Y/208Y
 PHASE: 3
 FREQ: 60 HZ
 WINDING MATL: Copper
 WEIGHT: 120 LBS
 INSUL. CLASS: 220°C
 TEMP. RISE: 150°C
 IMPEDANCE: 4.0 - 6.0%
 TAPS: SEE BELOW
 BIL: 10 kV
 ENCLOSURE: NEMA Type 2
 TYPE 3R with optional kit
 APPROVALS: UL, CSA

OUTLINE DRAWING

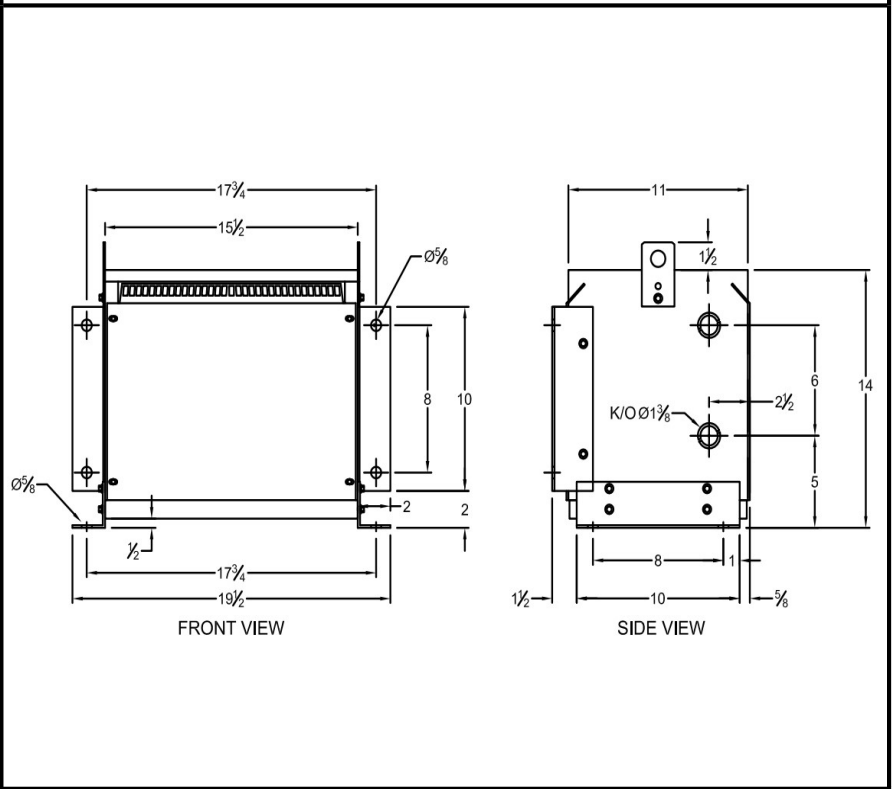

WIRING AND CONNECTION DIAGRAM

VOLT	LINE CONN
630	1-1-1
600	H1-H2-H3
570	2-2-2
480	X7-X8-X9
240	X4-X5-X6
208	X1-X2-X3

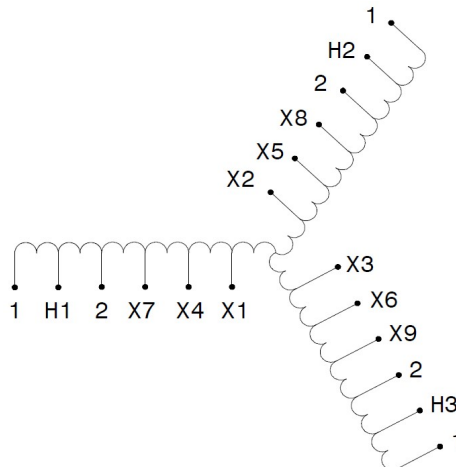

Supply voltage may be connected to primary terminal marked "H" or secondary terminal marked "X"

Review CEC rule 26-266 or CEC handbook figure 26-12 for more information

NOTE: Specifications and dimensions subject to change without notice