



BEAVER ELECTRICAL MACHINERY
 7440 LOWLAND DRIVE, BURNABY, BC, CANADA
 TEL: (604) 431-5000 FAX: (604) 431-5066
 www.beaverelectrical.com

**AVR SERIES
 SPECIFICATION SHEET**

**3 PHASE TRANSFORMER
 TYPE: DRY TYPE - ANN
 FLOOR MOUNT**

CAT. NO.: AVR10TQP4C
 KVA: 10
 VOLT: 600Y/400Y/380Y
 PHASE: 3
 FREQ: 60 HZ
 WINDING MATL: Copper
 WEIGHT: 110 LBS
 INSUL. CLASS: 220°C
 TEMP. RISE: 150°C
 TAPS: SEE BELOW
 BIL: 10 kV
 ENCLOSURE: NEMA 2
 NEMA 3R with optional kit
 APPROVALS: UL, CSA

OUTLINE DRAWING

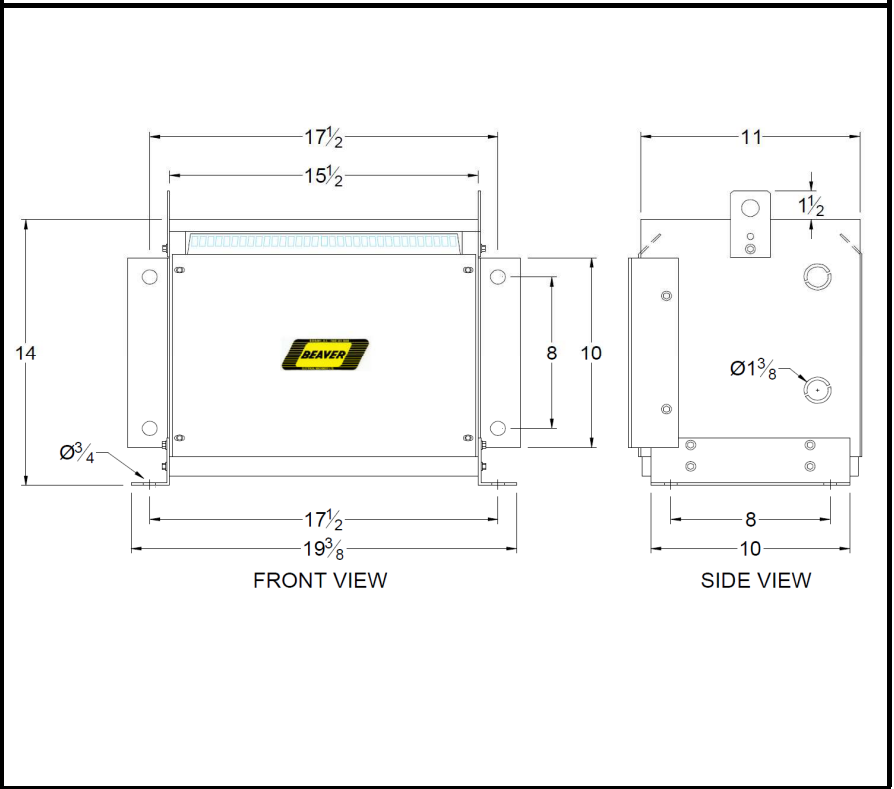

WIRING AND CONNECTION DIAGRAM

VOLT	LINE CONN
600	H1-H2-H3
400	A1-A2-A3
380	X1-X2-X3

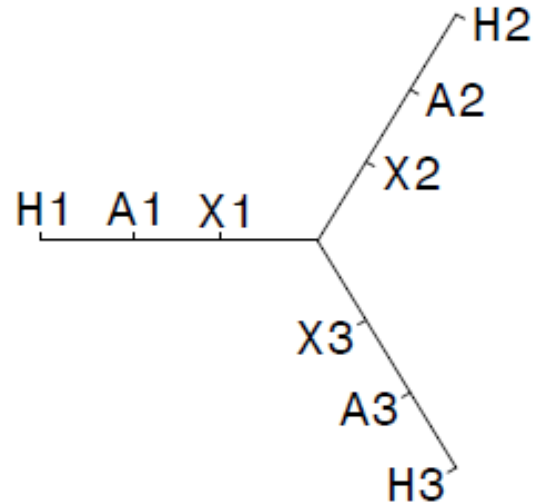

NOTE: Specifications and dimensions subject to change without notice