



Technical Documentation

APH15045-841

Advantage Plus IEEE 841 | AEHH8B

Beaver Electrical Machinery

Date: June 6, 2022

Dimensional Drawing

Catalogue	Type	HP	RPM	Voltage	Hz	Frame Size
APH15045-841	AEHH8B	150	1800	575	60	445T

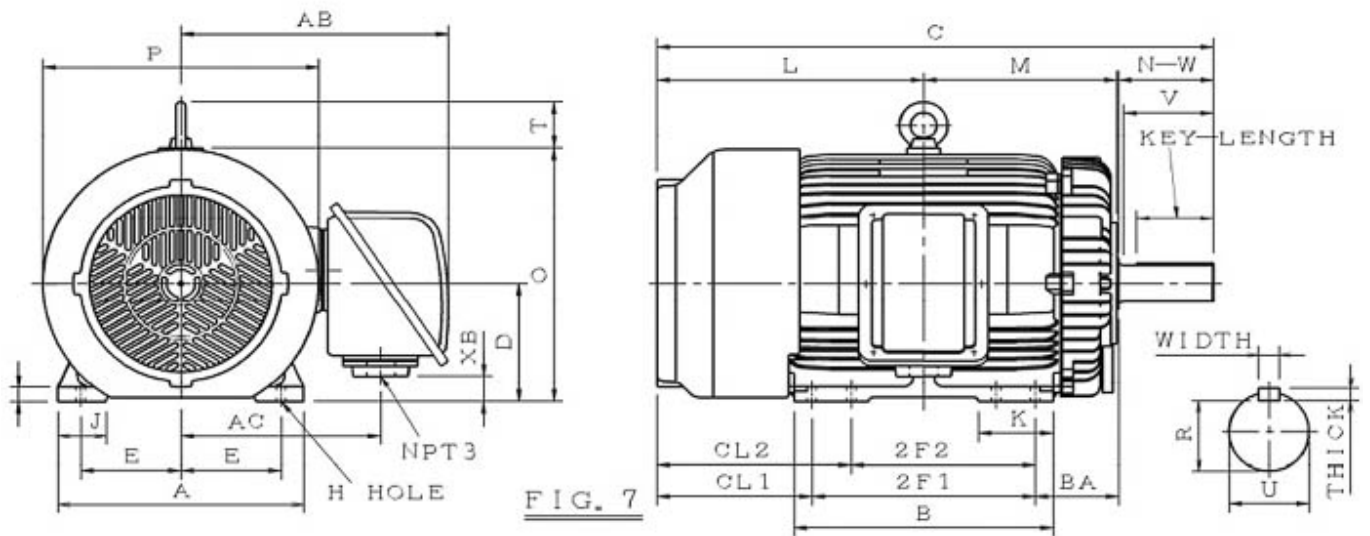



Mounting					A	B	C	CL1	CL2	D	G
E	2F1	2F2	H	BA							
9	16.5	14.5	0.81	7.5	22.05	19.5	46.4	13.9		11	1.4

J	K	L	M	O	P	T
4.35	5.1	22.15	15.4	23.55	24.75	4.35

Terminal Housing			
AA	AB	AC	XB
NPT3"	24	17.9	2.4

Shaft Extension			Key			Keyseat
N-W	U	V	Width	Thick	Length	R
8.5	3.375	8	0.875	0.875	6.91	2.88

Bearings		Weight Lbs	Drive Method	Dimensions
DE	NDE			
6318C3	6316C3	1811	Direct Coupling / Belt Drive	Inches

	Beaver Electrical Machinery	
	Date: June 6, 2022	

Technical Data Sheet

Motor Type: AEHH8B	Catalogue No: APH15045-841
--------------------	----------------------------

Nameplate Information

HP	Pole	RPM	Frame	Voltage	Hz	Phase
150	4	1783	445T	575	60	3
Enclosure	Ins. Class	Service Factor	Time Rating	NEMA Design	Rated Amb.	Rated Altitude
TEFC	F	1.15	Continuous	B	-40 to 40 °C	<1000 m

Typical Performance

Efficiency (%)				Power Factor (%)		
Full Load		3/4 Load	1/2 Load	Full Load	3/4 Load	1/2 Load
Nom.	Min.					
95.8	95	95.4	94.5	84	82	78
Torque				Current (A)		
Full Load (lb-ft)	Locked Rotor (% FLT)	Pull Up (% FLT)	Break Down (% FLT)	No Load	Full Load	Locked Rotor
442	130	100	220	37.3	139.6	868
NEMA KVA Code	Inertia (WR ²)			Safe Stall Time (s)		Noise Level Sound Press. dB(A)
	Rotor (lb-ft ²)	NEMA Load (lb-ft ²)	Max. Allowable (lb-ft ²)	Cold	Hot	
G	52	640	1280	25	17	81

VFD Duty Information

Max HP	Current (A)	Speed Range		VFD		S.F.
		Constant Torque	Variable Torque	Carrier Hz	Type	
150	139.63	12-60Hz	3-60Hz	3-6kHz	VPWM or CPWM	1

Hazardous Locations Information



CSA Certified	
Class I, Div 2, Groups B, C & D Class I, Zone 2, Groups IIB+H2, IIB & IIA	
Temp Code (Sinewave / VFD)	T3C / T3

Additional Certifications

Other Certification

Additional Information

Bearings		Approx. Weight
DE	NDE	lbs
6318C3	6316C3	1811

	Beaver Electrical Machinery	
	Date: June 6, 2022	

Nameplate Drawing

Advantage Plus IEEE 841					
TYPE	AEHH8B	CAT. NO.	APH15045-841		
OUTPUT	150 HP 111.9 kW	FRAME	445T	TEFC	
R.P.M.	1783	POLE	4	INS.	F
VOLTS	575	PHASE	3	Hz	60
AMPS	139.6	CODE	G	S.F.	1.15
AMBIENT	40 °C	NOM. EFF. 95.8		MIN. EFF. 95	
BEARINGS	6318C3 / 6316C3			RATING Cont.	
SER. NO.	TBD	DESIGN	B	WT. 1811 LBS	
PWM VFD DUTY	VT	CT	CP	S.F.	
	3-60Hz	12-60Hz	60-90Hz	1	



Connection Diagram

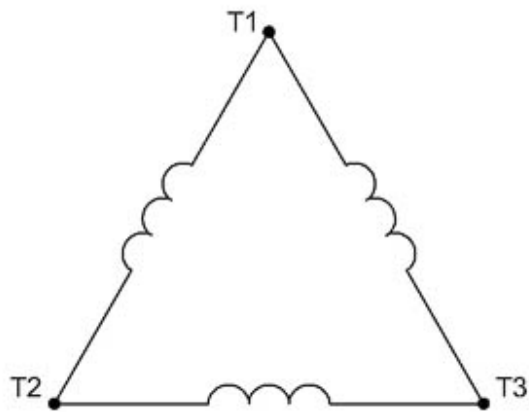

3 LEAD		SINGLE VOLTAGE			DELTA
VOLTAGE	CONN.	L1	L2	L3	
-	DELTA	1	2	3	

WD_3D



Thermal Limit Curves

Motor Type: AEHH8B		Catalogue No: APH15045-841		Family: Advantage Plus IEEE 841	
HP	150	Safe Stall Time		Full Load A	139.6 A
Voltage	575V 60Hz	Hot	17 s	% Inrush	622 %
RPM	1800	Cold	25 s	Locked Rotor A	868 A

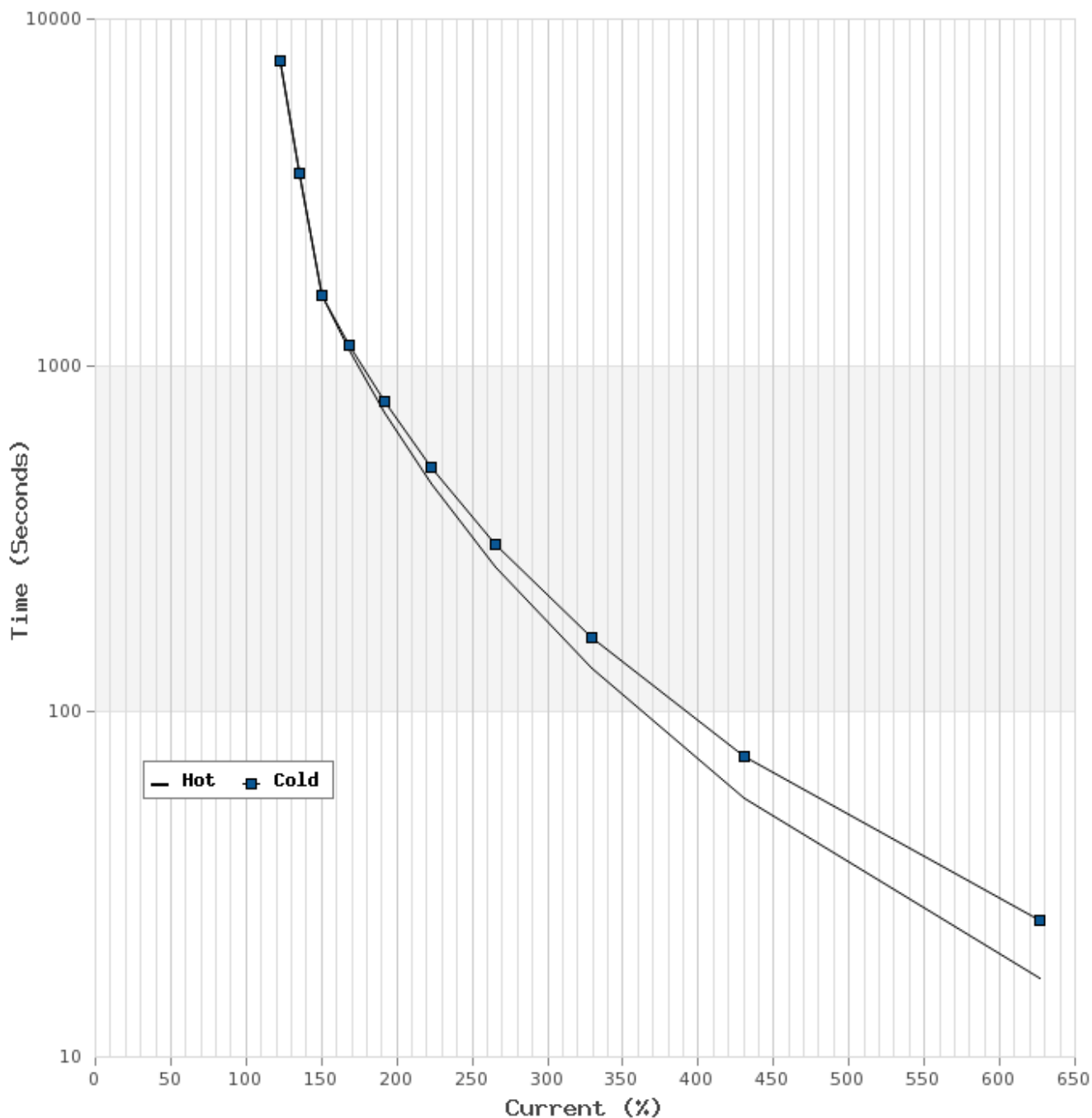



T-N and I-N Curves

Motor Type: AEHH8B		Catalogue No: APH15045-841		Family: Advantage Plus IEEE 841	
HP	150	Full Load T	442 lb-ft	Full Load A	139.6 A
Voltage	575V 60Hz	Locked Rotor T	130 %	Locked Rotor A	868.0 A
RPM	1800	Pull Up T	100 %	Break Down T	220 %

