



Technical Documentation

APH15025-841

Advantage Plus IEEE 841 | AEHH8B

Beaver Electrical Machinery

Date: June 6, 2022

Dimensional Drawing

Catalogue	Type	HP	RPM	Voltage	Hz	Frame Size
APH15025-841	AEHH8B	150	3600	575	60	445TS

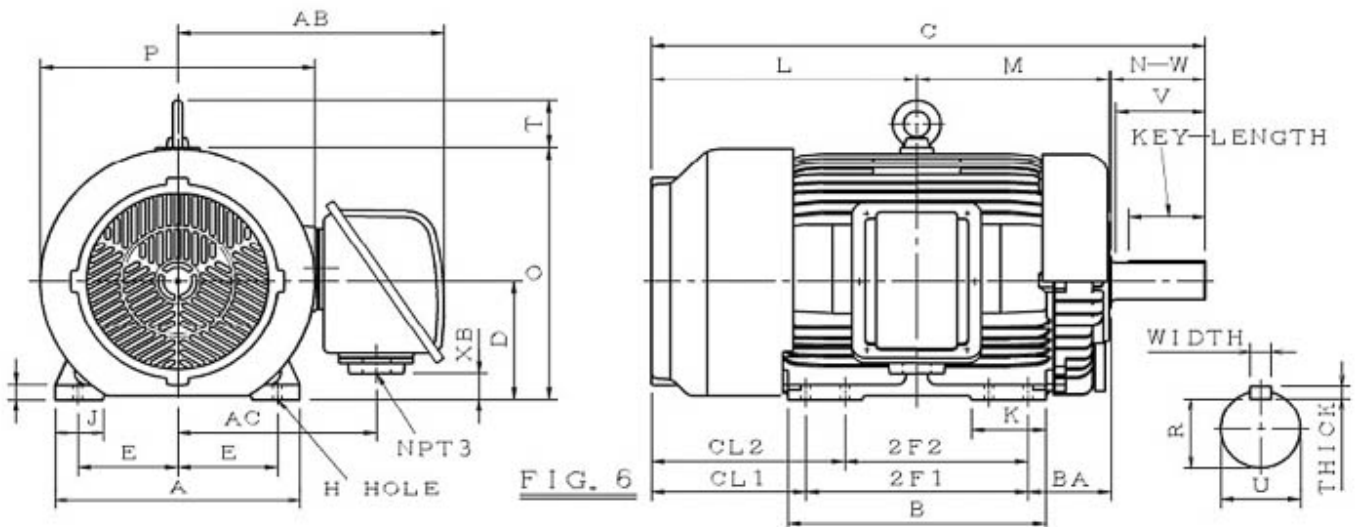



Mounting					A	B	C	CL1	CL2	D	G
E	2F1	2F2	H	BA							
9	16.5	14.5	0.81	7.5	22.05	19.5	42.65	13.9		11	1.4

J	K	L	M	O	P	T
4.35	5.1	22.15	15.4	23.55	24.75	4.35

Terminal Housing			
AA	AB	AC	XB
NPT3"	24	17.9	2.4

Shaft Extension			Key			Keyseat
N-W	U	V	Width	Thick	Length	R
4.75	2.375	4.5	0.625	0.625	3.03	2.021

Bearings		Weight Lbs	Drive Method	Dimensions
DE	NDE			
6314C3	6314C3	1696	Direct Coupling	Inches

	Beaver Electrical Machinery	
	Date: June 6, 2022	

Technical Data Sheet

Motor Type: AEHH8B	Catalogue No: APH15025-841
--------------------	----------------------------

Nameplate Information

HP	Pole	RPM	Frame	Voltage	Hz	Phase
150	2	3570	445TS	575	60	3
Enclosure	Ins. Class	Service Factor	Time Rating	NEMA Design	Rated Amb.	Rated Altitude
TEFC	F	1.15	Continuous	B	-40 to 40 °C	<1000 m

Typical Performance

Efficiency (%)				Power Factor (%)		
Full Load		3/4 Load	1/2 Load	Full Load	3/4 Load	1/2 Load
Nom.	Min.					
95	94.1	94.5	93.6	87	84.5	81
Torque				Current (A)		
Full Load (lb-ft)	Locked Rotor (% FLT)	Pull Up (% FLT)	Break Down (% FLT)	No Load	Full Load	Locked Rotor
220	110	88	220	33.6	136.0	868
NEMA KVA Code	Inertia (WR ²)			Safe Stall Time (s)		Noise Level Sound Press. dB(A)
	Rotor (lb-ft ²)	NEMA Load (lb-ft ²)	Max. Allowable (lb-ft ²)	Cold	Hot	
G	20	133	133	28	19	83

VFD Duty Information

Max HP	Current (A)	Speed Range		VFD		S.F.
		Constant Torque	Variable Torque	Carrier Hz	Type	
150	135.95	12-60Hz	3-60Hz	3-6kHz	VPWM or CPWM	1

Hazardous Locations Information



CSA Certified	
Class I, Div 2, Groups B, C & D Class I, Zone 2, Groups IIB+H2, IIB & IIA	
Temp Code (Sinewave / VFD)	T3C / T3

Additional Certifications

Other Certification

Additional Information

Bearings		Approx. Weight
DE	NDE	lbs
6314C3	6314C3	1696

	Beaver Electrical Machinery	
	Date: June 6, 2022	

Nameplate Drawing

Advantage Plus IEEE 841					
TYPE	AEHH8B		CAT. NO.	APH15025-841	
OUTPUT	150 HP 111.9 kW		FRAME	445TS	TEFC
R.P.M.	3570		POLE	2	INS. F
VOLTS	575		PHASE	3	Hz 60
AMPS	136.0		CODE	G	S.F. 1.15
AMBIENT	40 °C		NOM. EFF. 95		MIN. EFF. 94.1
BEARINGS	6314C3 / 6314C3				RATING Cont.
SER. NO.	TBD		DESIGN	B	WT. 1696 LBS
PWM VFD DUTY	VT	CT	CP	S.F.	
	3-60Hz	12-60Hz	60-60Hz	1	



Connection Diagram

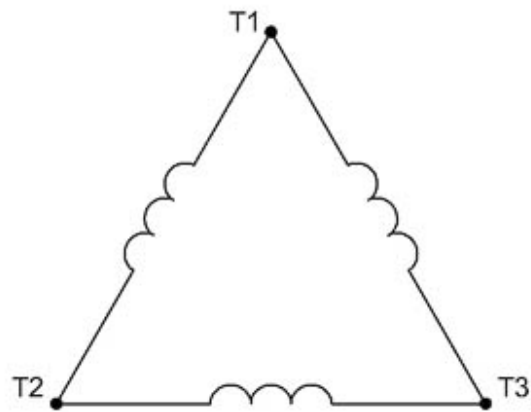

3 LEAD		SINGLE VOLTAGE			DELTA
VOLTAGE	CONN.	L1	L2	L3	
-	DELTA	1	2	3	

WD_3D



Thermal Limit Curves

Motor Type: AEHH8B		Catalogue No: APH15025-841		Family: Advantage Plus IEEE 841	
HP	150	Safe Stall Time		Full Load A	136.0 A
Voltage	575V 60Hz	Hot	19 s	% Inrush	638 %
RPM	3600	Cold	28 s	Locked Rotor A	868 A

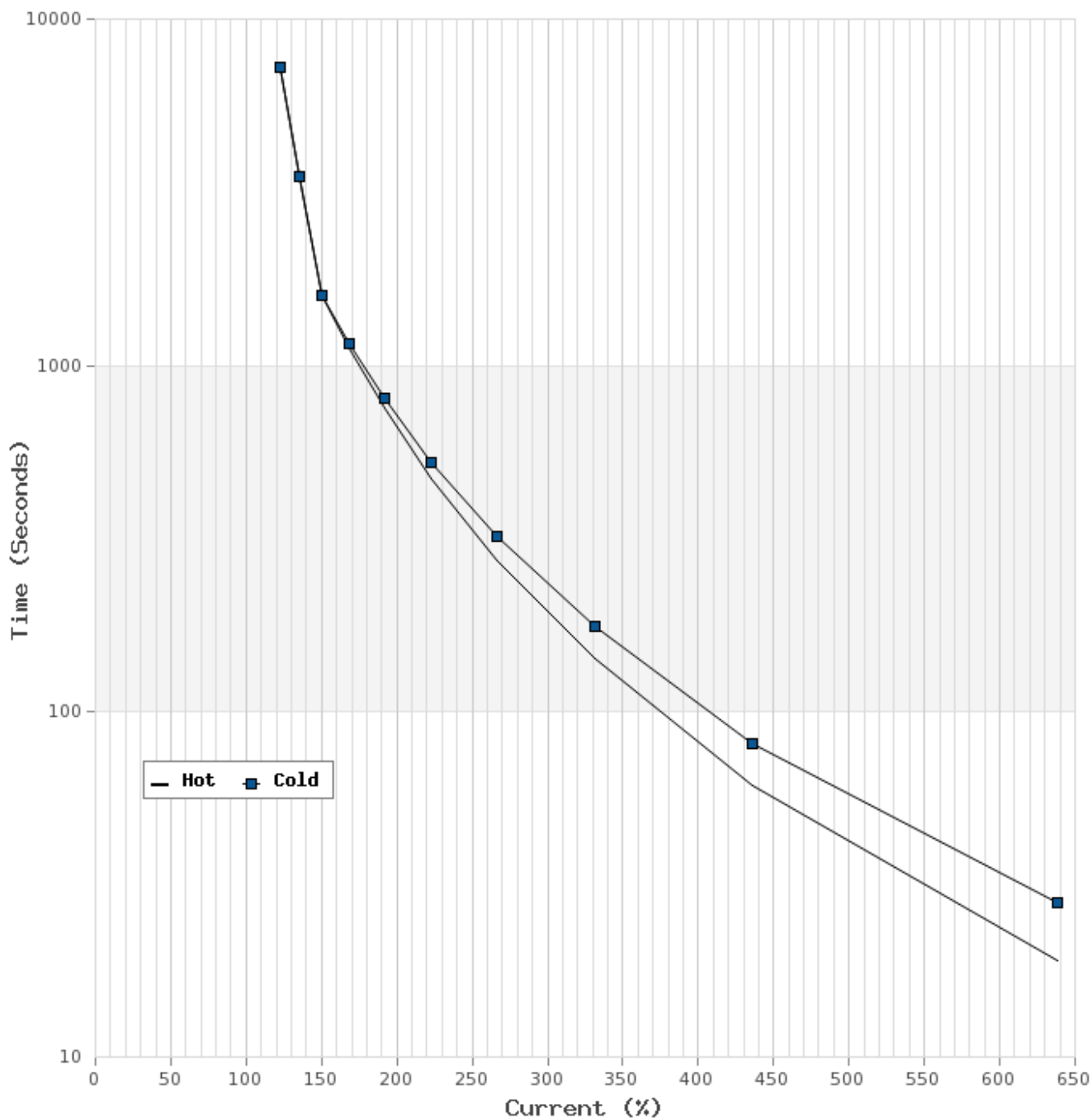



T-N and I-N Curves

Motor Type: AEHH8B		Catalogue No: APH15025-841		Family: Advantage Plus IEEE 841	
HP	150	Full Load T	220 lb-ft	Full Load A	136.0 A
Voltage	575V 60Hz	Locked Rotor T	110 %	Locked Rotor A	868.0 A
RPM	3600	Pull Up T	88 %	Break Down T	220 %

