



Technical Documentation

# **APH1256-841**

## **Advantage Plus IEEE 841 | AEHH8B**

Beaver Electrical Machinery

Date: June 6, 2022

### Dimensional Drawing

Catalogue	Type	HP	RPM	Voltage	Hz	Frame Size
APH1256-841	AEHH8B	125	1200	460	60	445T

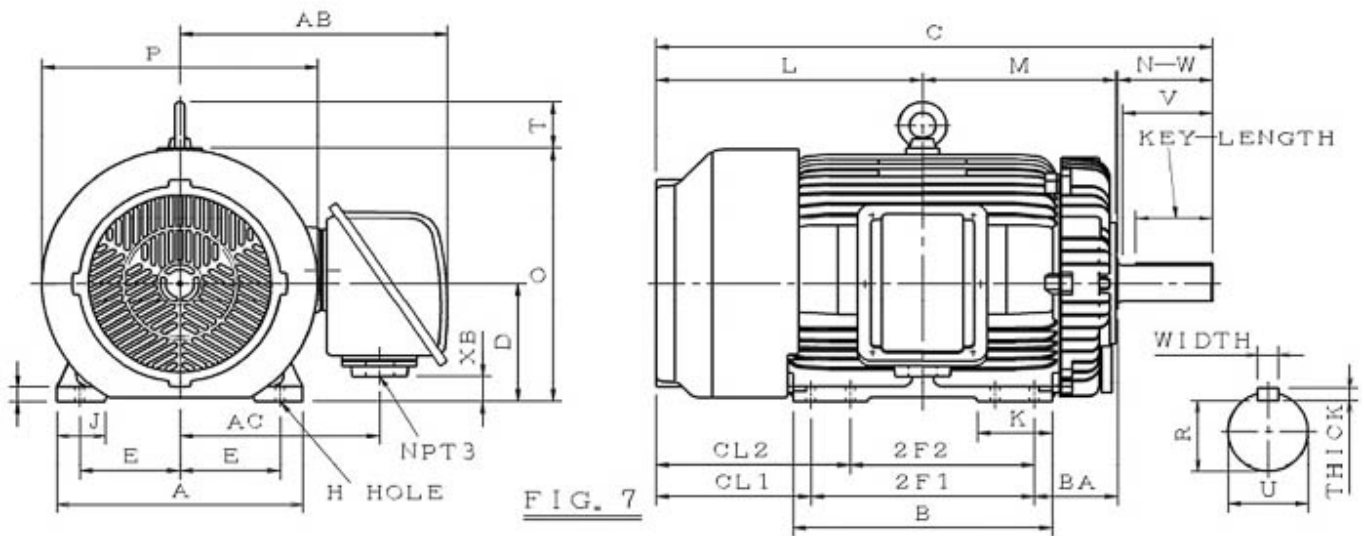



Mounting					A	B	C	CL1	CL2	D	G
E	2F1	2F2	H	BA							
9	16.5	14.5	0.81	7.5	22.05	19.5	46.4	13.9		11	1.4

J	K	L	M	O	P	T
4.35	5.1	22.15	15.4	23.55	24.75	4.35

Terminal Housing			
AA	AB	AC	XB
NPT3"	24	17.9	2.4

Shaft Extension			Key			Keyseat
N-W	U	V	Width	Thick	Length	R
8.5	3.375	8	0.875	0.875	6.91	2.88

Bearings		Weight Lbs	Drive Method	Dimensions
DE	NDE			
6318C3	6316C3	1903	Direct Coupling / Belt Drive	Inches

	Beaver Electrical Machinery	
	Date: June 6, 2022	

### Technical Data Sheet

Motor Type: AEHH8B	Catalogue No: APH1256-841
--------------------	---------------------------

#### Nameplate Information

HP	Pole	RPM	Frame	Voltage	Hz	Phase
125	6	1185	445T	460	60	3
Enclosure	Ins. Class	Service Factor	Time Rating	NEMA Design	Rated Amb.	Rated Altitude
TEFC	F	1.15	Continuous	B	-40 to 40 °C	<1000 m

#### Typical Performance

Efficiency (%)				Power Factor (%)		
Full Load		3/4 Load	1/2 Load	Full Load	3/4 Load	1/2 Load
Nom.	Min.					
95	94.1	94.5	93.6	83	80.5	74
Torque				Current (A)		
Full Load (lb-ft)	Locked Rotor (% FLT)	Pull Up (% FLT)	Break Down (% FLT)	No Load	Full Load	Locked Rotor
554	140	110	230	59.7	148.4	907.5
NEMA KVA Code	Inertia (WR <sup>2</sup> )			Safe Stall Time (s)		Noise Level Sound Press. dB(A)
	Rotor (lb-ft <sup>2</sup> )	NEMA Load (lb-ft <sup>2</sup> )	Max. Allowable (lb-ft <sup>2</sup> )	Cold	Hot	
G	68	1452	3630	17	12	77

#### VFD Duty Information

Max HP	Current (A)	Speed Range		VFD		S.F.
		Constant Torque	Variable Torque	Carrier Hz	Type	
125	148.44	12-60Hz	3-60Hz	3-6kHz	VPWM or CPWM	1

#### Hazardous Locations Information



CSA Certified
Class I, Div 2, Groups B, C & D Class I, Zone 2, Groups IIB+H2, IIB & IIA
Temp Code (Sinewave / VFD)
T3C / T3

#### Additional Certifications

Other Certification
Class II, Div 2, Groups F & G

#### Additional Information

Bearings		Approx. Weight
DE	NDE	lbs
6318C3	6316C3	1903

	Beaver Electrical Machinery	
	Date: June 6, 2022	

### Nameplate Drawing

Advantage Plus IEEE 841					
TYPE	AEHH8B		CAT. NO.	APH1256-841	
OUTPUT	125 HP 93.25 kW		FRAME	445T	TEFC
R.P.M.	1185		POLE	6	INS. F
VOLTS	460		PHASE	3	Hz 60
AMPS	148.4		CODE	G	S.F. 1.15
AMBIENT	40 °C		NOM. EFF. 95		MIN. EFF. 94.1
BEARINGS	6318C3 / 6316C3				RATING Cont.
SER. NO.	TBD		DESIGN	B	WT. 1903 LBS
PWM VFD DUTY	VT	CT	CP	S.F.	
	3-60Hz	12-60Hz	60-90Hz	1	



### Connection Diagram

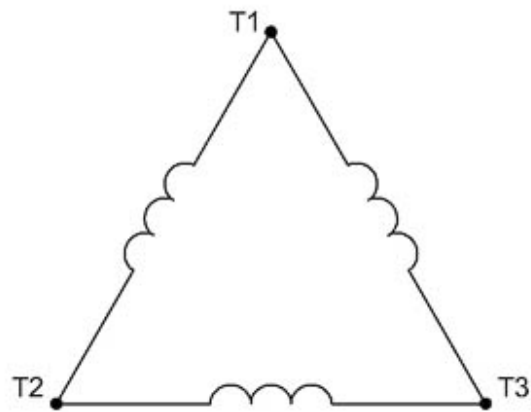

3 LEAD SINGLE VOLTAGE DELTA					
VOLTAGE	CONN.	L1	L2	L3	
-	DELTA	1	2	3	

WD\_3D



### Thermal Limit Curves

Motor Type: AEHH8B		Catalogue No: APH1256-841		Family: Advantage Plus IEEE 841	
HP	125	Safe Stall Time		Full Load A	148.4 A
Voltage	460V 60Hz	Hot	12 s	% Inrush	611 %
RPM	1200	Cold	17 s	Locked Rotor A	907.5 A

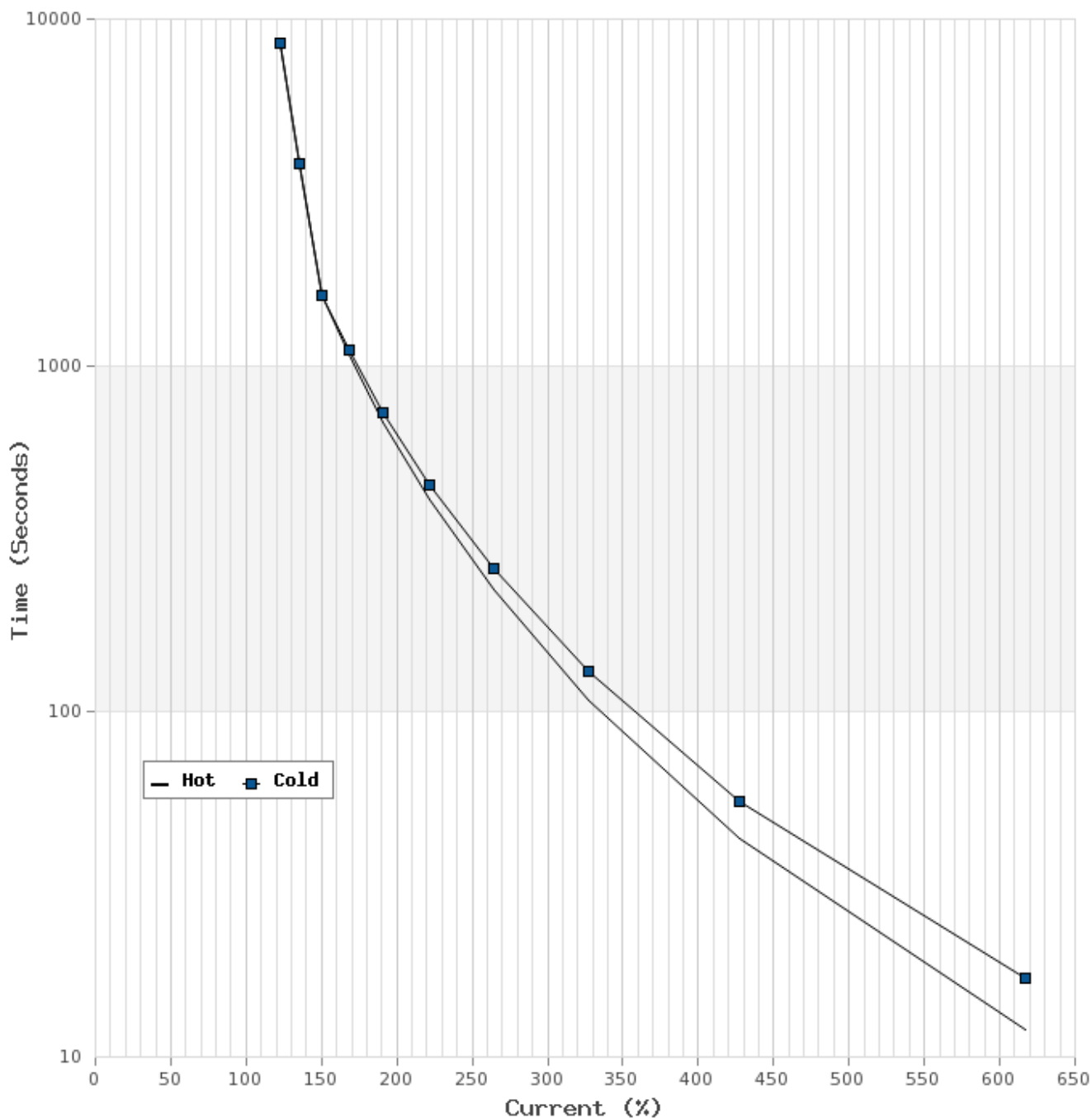



### T-N and I-N Curves

Motor Type: AEHH8B		Catalogue No: APH1256-841		Family: Advantage Plus IEEE 841	
HP	125	Full Load T	554 lb-ft	Full Load A	148.4 A
Voltage	460V 60Hz	Locked Rotor T	140 %	Locked Rotor A	907.5 A
RPM	1200	Pull Up T	110 %	Break Down T	230 %

