



Technical Documentation

APH07545-841

Advantage Plus IEEE 841 | AEHH8B

Beaver Electrical Machinery

Date: June 6, 2022



Dimensional Drawing

Catalogue	Type	HP	RPM	Voltage	Hz	Frame Size
APH07545-841	AEHH8B	75	1800	575	60	365T

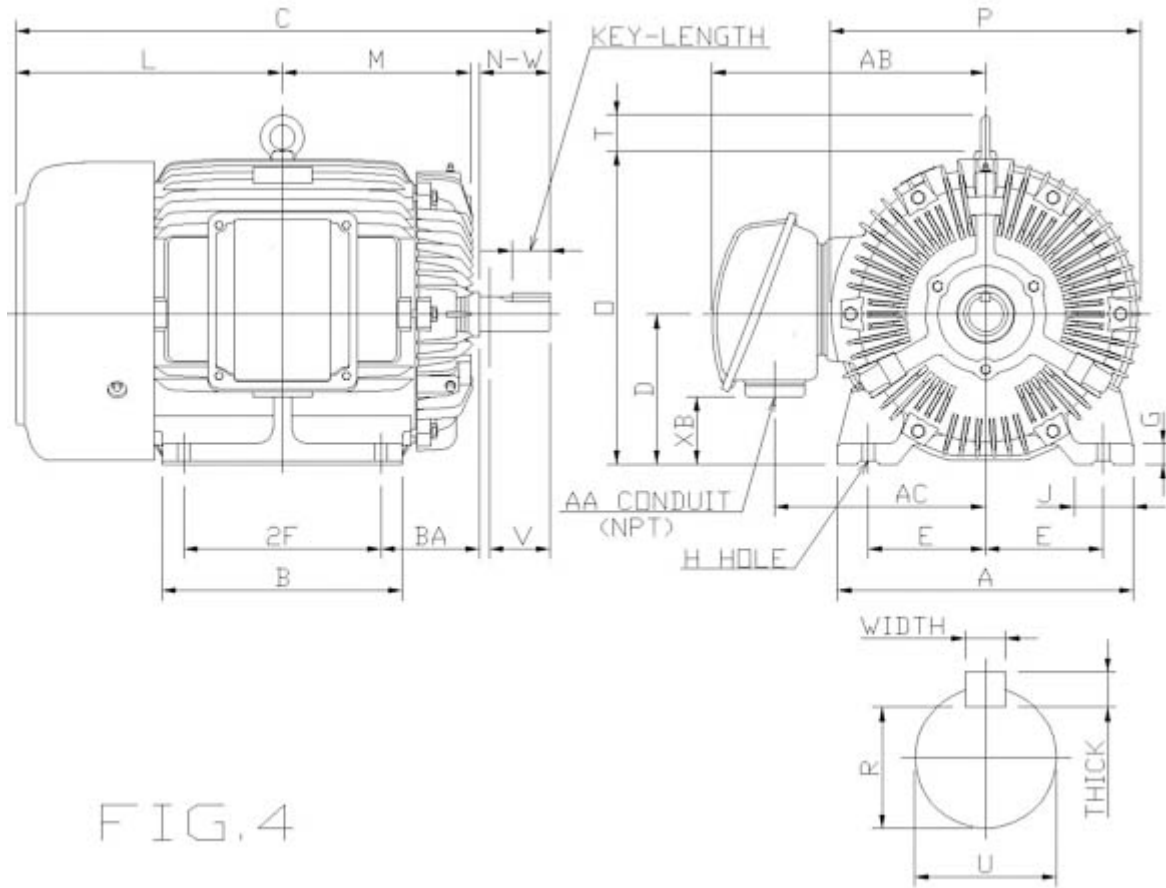

FIG. 4



Mounting					A	B	C	CL1	CL2	D	G
E	2F1	2F2	H	BA							
7	12.25	11.25	0.66	5.88	17.7	14.76	33.55			9	1.32

J	K	L	M	O	P	T
3.54		15.67	11.59	17.99	18.03	2.76

Terminal Housing			
AA	AB	AC	XB
NPT3"	16.81	12.99	2.39

Shaft Extension			Key			Keyseat
N-W	U	V	Width	Thick	Length	R
5.88	2.375	5.75	0.625	0.625	4.28	2.021

Bearings		Weight Lbs	Drive Method	Dimensions
DE	NDE			
6313ZC3	6213ZC3	972	Direct Coupling / Belt Drive	Inches

	Beaver Electrical Machinery	
	Date: June 6, 2022	

Technical Data Sheet

Motor Type: AEHH8B	Catalogue No: APH07545-841
--------------------	----------------------------

Nameplate Information

HP	Pole	RPM	Frame	Voltage	Hz	Phase
75	4	1775	365T	575	60	3
Enclosure	Ins. Class	Service Factor	Time Rating	NEMA Design	Rated Amb.	Rated Altitude
TEFC	F	1.15	Continuous	B	-40 to 40 °C	<1000 m

Typical Performance

Efficiency (%)				Power Factor (%)		
Full Load		3/4 Load	1/2 Load	Full Load	3/4 Load	1/2 Load
Nom.	Min.					
95.4	94.5	95.4	95	86.5	83.5	75.5
Torque				Current (A)		
Full Load (lb-ft)	Locked Rotor (% FLT)	Pull Up (% FLT)	Break Down (% FLT)	No Load	Full Load	Locked Rotor
221.8	200	165	250	20.8	68.1	434.4
NEMA KVA Code	Inertia (WR ²)			Safe Stall Time (s)		Noise Level Sound Press. dB(A)
	Rotor (lb-ft ²)	NEMA Load (lb-ft ²)	Max. Allowable (lb-ft ²)	Cold	Hot	
G	14.674	338	618	17	12	79

VFD Duty Information

Max HP	Current (A)	Speed Range		VFD		S.F.
		Constant Torque	Variable Torque	Carrier Hz	Type	
75	68.08	6-60Hz	3-60Hz	3-6kHz	VPWM or CPWM	1

Hazardous Locations Information



CSA Certified	
Class I, Div 2, Groups B, C & D Class I, Zone 2, Groups IIB+H2, IIB & IIA	
Temp Code (Sinewave / VFD)	T3C / T3

Additional Certifications

Other Certification

Additional Information

Bearings		Approx. Weight
DE	NDE	lbs
6313ZC3	6213ZC3	972

	Beaver Electrical Machinery	
	Date: June 6, 2022	

Nameplate Drawing

Advantage Plus IEEE 841					
TYPE	AEHH8B		CAT. NO.	APH07545-841	
OUTPUT	75 HP 55.95 kW		FRAME	365T	TEFC
R.P.M.	1775		POLE	4	INS. F
VOLTS	575		PHASE	3	Hz 60
AMPS	68.1		CODE	G	S.F. 1.15
AMBIENT	40 °C		NOM. EFF. 95.4		MIN. EFF. 94.5
BEARINGS	6313ZC3 / 6213ZC3				RATING Cont.
SER. NO.	TBD		DESIGN	B	WT. 972 LBS
PWM VFD DUTY	VT	CT	CP	S.F.	
	3-60Hz	6-60Hz	60-90Hz	1	



Connection Diagram

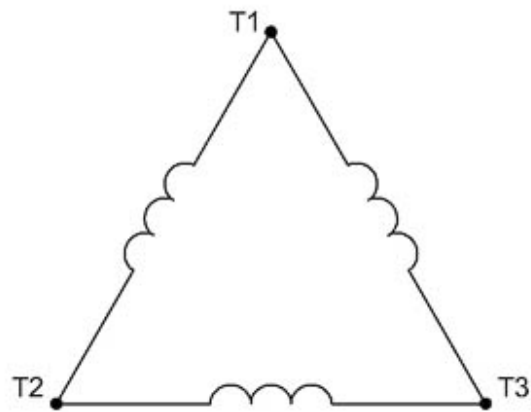

3 LEAD		SINGLE VOLTAGE			DELTA
VOLTAGE	CONN.	L1	L2	L3	
-	DELTA	1	2	3	

WD_3D



Thermal Limit Curves

Motor Type: AEHH8B		Catalogue No: APH07545-841		Family: Advantage Plus IEEE 841	
HP	75	Safe Stall Time		Full Load A	68.1 A
Voltage	575V 60Hz	Hot	12 s	% Inrush	638 %
RPM	1800	Cold	17 s	Locked Rotor A	434.4 A

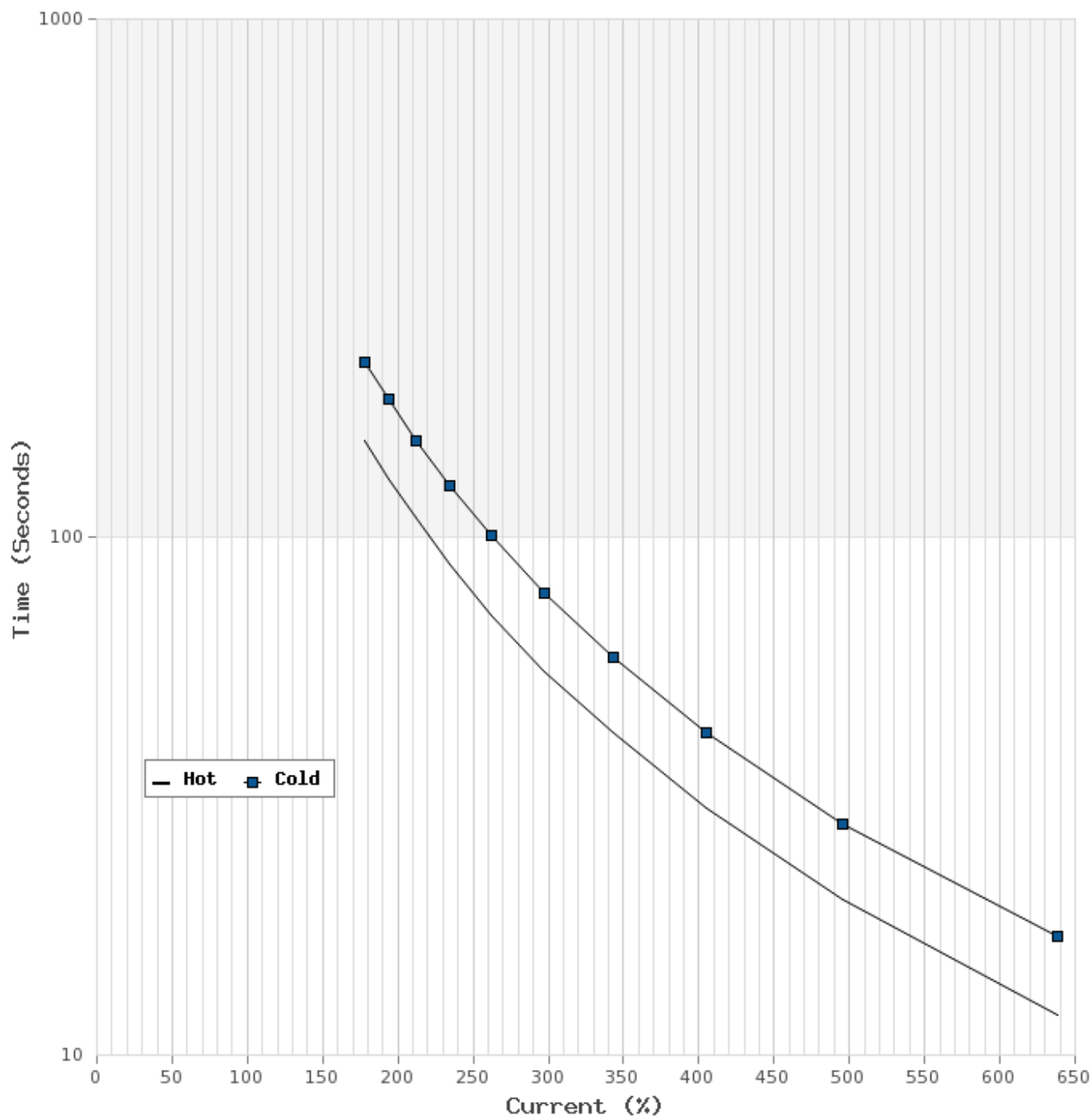



T-N and I-N Curves

Motor Type: AEHH8B		Catalogue No: APH07545-841		Family: Advantage Plus IEEE 841	
HP	75	Full Load T	221.8 lb-ft	Full Load A	68.1 A
Voltage	575V 60Hz	Locked Rotor T	200 %	Locked Rotor A	434.4 A
RPM	1800	Pull Up T	165 %	Break Down T	250 %

