	Beaver Electrical Machinery Ltd.	
	Date: July 25, 2022	

Technical Documentation

APH06065-841

Advantage Plus IEEE 841 | AEHH8B

Beaver Electrical Machinery Ltd.
Date: July 25, 2022



Dimensional Drawing

Catalogue	Type	HP	RPM	Voltage	Hz	Frame Size
APH06065-841	AEHH8B	60	1200	575	60	404T

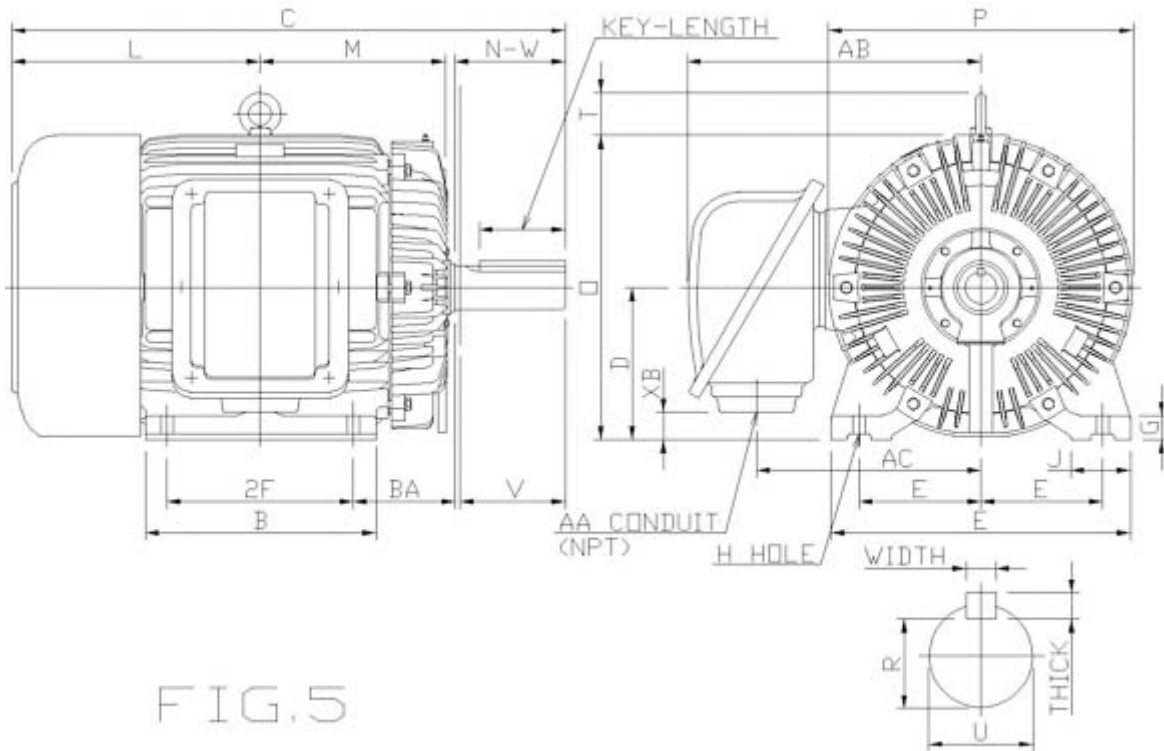



Mounting					A	B	C	CL1	CL2	D	G
E	2F1	2F2	H	BA							
8	12.25		0.81	6.62	19.68	15.16	36.49			10	1.57

J	K	L	M	O	P	T
3.94		16.49	12.52	20	20.08	3.54

Terminal Housing			
AA	AB	AC	XB
NPT3"	19.41	14.76	1.81

Shaft Extension			Key			Keyseat
N-W	U	V	Width	Thick	Length	R
7.25	2.875	7.16	0.75	0.75	5.65	2.45

Bearings		Weight Lbs	Drive Method	Dimensions
DE	NDE			
6317C3	6313ZC3	1245	Direct Coupling / Belt Drive	Inches

	Beaver Electrical Machinery Ltd.	
	Date: July 25, 2022	

Technical Data Sheet

Motor Type: AEHH8B	Catalogue No: APH06065-841
--------------------	----------------------------

Nameplate Information

HP	Pole	RPM	Frame	Voltage	Hz	Phase
60	6	1180	404T	575	60	3
Enclosure	Ins. Class	Service Factor	Time Rating	NEMA Design	Rated Amb.	Rated Altitude
TEFC	F	1.15	Continuous	B	-40 to 40 °C	<1000 m

Typical Performance

Efficiency (%)				Power Factor (%)		
Full Load		3/4 Load	1/2 Load	Full Load	3/4 Load	1/2 Load
Nom.	Min.					
94.5	93.6	94.5	94.1	87	86.5	80.5
Torque				Current (A)		
Full Load (lb-ft)	Locked Rotor (% FLT)	Pull Up (% FLT)	Break Down (% FLT)	No Load	Full Load	Locked Rotor
267	200	185	245	14.5	54.7	348
NEMA KVA Code	Inertia (WR ²)			Safe Stall Time (s)		Noise Level Sound Press. dB(A)
	Rotor (lb-ft ²)	NEMA Load (lb-ft ²)	Max. Allowable (lb-ft ²)	Cold	Hot	
G	33.53	735	1828	34	24	78

VFD Duty Information

Max HP	Current (A)	Speed Range		VFD		S.F.
		Constant Torque	Variable Torque	Carrier Hz	Type	
60	54.67	6-60Hz	3-60Hz	3-6kHz	VPWM or CPWM	1

Hazardous Locations Information



CSA Certified
Class I, Div 2, Groups B, C & D Class I, Zone 2, Groups IIB+H2, IIB & IIA
Temp Code (Sinewave / VFD)
T3C / T3

Additional Certifications

Other Certification

Additional Information

Bearings		Approx. Weight
DE	NDE	lbs
6317C3	6313ZC3	1245

	Beaver Electrical Machinery Ltd.	
	Date: July 25, 2022	

Nameplate Drawing

Advantage Plus IEEE 841					
TYPE	AEHH8B		CAT. NO.	APH06065-841	
OUTPUT	60 HP 44.76 kW		FRAME	404T	TEFC
R.P.M.	1180		POLE	6	INS. F
VOLTS	575		PHASE	3	Hz 60
AMPS	54.7		CODE	G	S.F. 1.15
AMBIENT	40 °C		NOM. EFF. 94.5		MIN. EFF. 93.6
BEARINGS	6317C3 / 6313ZC3				RATING Cont.
SER. NO.	TBD		DESIGN	B	WT. 1245 LBS
PWM VFD DUTY	VT	CT	CP	S.F.	
	3-60Hz	6-60Hz	60-120Hz	1	



Connection Diagram

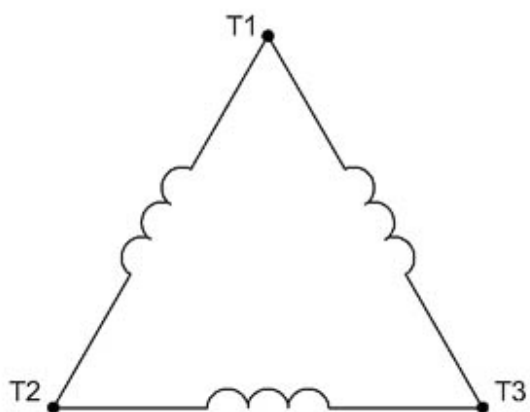

3 LEAD SINGLE VOLTAGE DELTA					
VOLTAGE	CONN.	L1	L2	L3	
-	DELTA	1	2	3	

WD_3D



Thermal Limit Curves

Motor Type: AEHH8B		Catalogue No: APH06065-841		Family: Advantage Plus IEEE 841	
HP	60	Safe Stall Time		Full Load A	54.7 A
Voltage	575V 60Hz	Hot	24 s	% Inrush	637 %
RPM	1200	Cold	34 s	Locked Rotor A	348 A

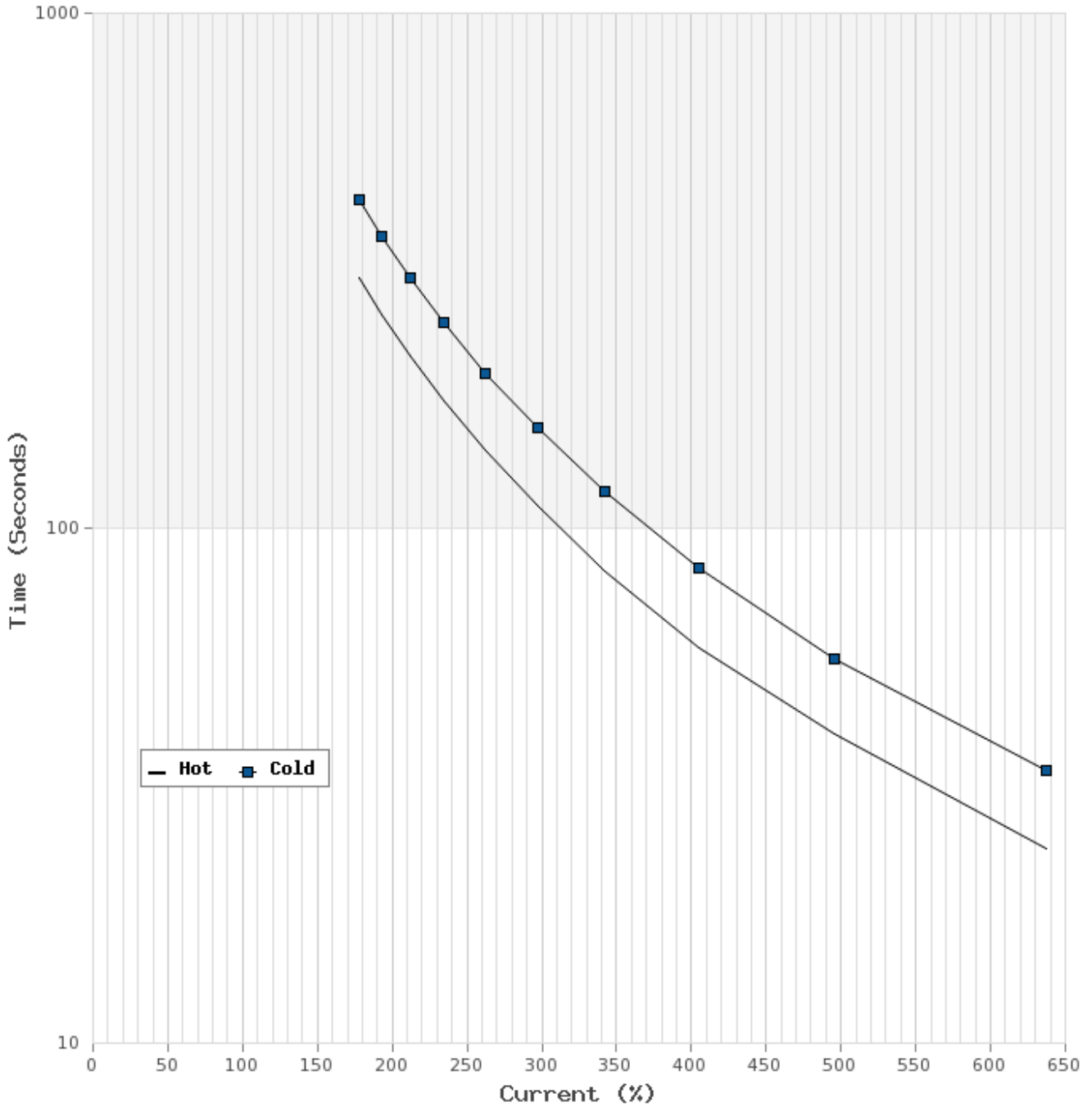



T-N and I-N Curves

Motor Type: AEHH8B		Catalogue No: APH06065-841		Family: Advantage Plus IEEE 841	
HP	60	Full Load T	267 lb-ft	Full Load A	54.7 A
Voltage	575V 60Hz	Locked Rotor T	200 %	Locked Rotor A	348.0 A
RPM	1200	Pull Up T	185 %	Break Down T	245 %

