



Technical Documentation

# **APH06045-841**

## **Advantage Plus IEEE 841 | AEHH8B**

Beaver Electrical Machinery Ltd.

Date: July 25, 2022



**Dimensional Drawing**

Catalogue	Type	HP	RPM	Voltage	Hz	Frame Size
APH06045-841	AEHH8B	60	1800	575	60	364T

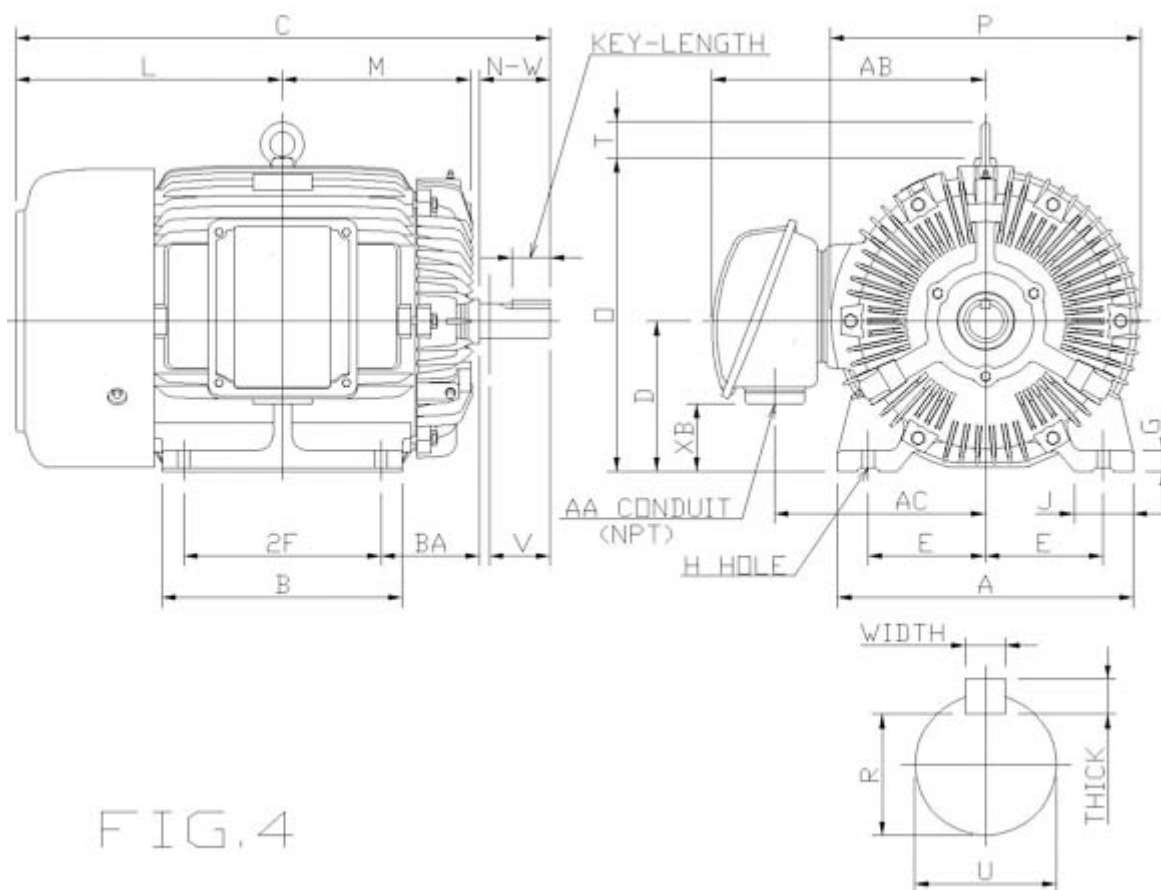



Mounting					A	B	C	CL1	CL2	D	G
E	2F1	2F2	H	BA							
7	11.25		0.66	5.88	17.7	13.78	32.57			9	1.32

J	K	L	M	O	P	T
3.54		15.17	11.09	17.99	18.03	2.76

Terminal Housing			
AA	AB	AC	XB
NPT3"	16.81	12.99	2.39

Shaft Extension			Key			Keyseat
N-W	U	V	Width	Thick	Length	R
5.88	2.375	5.75	0.625	0.625	4.28	2.021

Bearings		Weight Lbs	Drive Method	Dimensions
DE	NDE			
6313ZC3	6213ZC3	873	Direct Coupling / Belt Drive	Inches

	Beaver Electrical Machinery Ltd.	
	Date: July 25, 2022	

### Technical Data Sheet

Motor Type: AEHH8B	Catalogue No: APH06045-841
--------------------	----------------------------

#### Nameplate Information

HP	Pole	RPM	Frame	Voltage	Hz	Phase
60	4	1775	364T	575	60	3
Enclosure	Ins. Class	Service Factor	Time Rating	NEMA Design	Rated Amb.	Rated Altitude
TEFC	F	1.15	Continuous	B	-40 to 40 °C	<1000 m

#### Typical Performance

Efficiency (%)				Power Factor (%)		
Full Load		3/4 Load	1/2 Load	Full Load	3/4 Load	1/2 Load
Nom.	Min.					
95	94.1	95	94.5	86.5	83	75.5
Torque				Current (A)		
Full Load (lb-ft)	Locked Rotor (% FLT)	Pull Up (% FLT)	Break Down (% FLT)	No Load	Full Load	Locked Rotor
177.5	200	155	240	17.0	54.7	348
NEMA KVA Code	Inertia (WR <sup>2</sup> )			Safe Stall Time (s)		Noise Level Sound Press. dB(A)
	Rotor (lb-ft <sup>2</sup> )	NEMA Load (lb-ft <sup>2</sup> )	Max. Allowable (lb-ft <sup>2</sup> )	Cold	Hot	
G	12.229	275	583	17	12	79

#### VFD Duty Information

Max HP	Current (A)	Speed Range		VFD		S.F.
		Constant Torque	Variable Torque	Carrier Hz	Type	
60	54.69	6-60Hz	3-60Hz	3-6kHz	VPWM or CPWM	1

#### Hazardous Locations Information



CSA Certified	
Class I, Div 2, Groups B, C & D Class I, Zone 2, Groups IIB+H2, IIB & IIA	
Temp Code (Sinewave / VFD)	T3C / T3

#### Additional Certifications

Other Certification
---------------------

#### Additional Information

Bearings		Approx. Weight
DE	NDE	lbs
6313ZC3	6213ZC3	873

	Beaver Electrical Machinery Ltd.	
	Date: July 25, 2022	

### Nameplate Drawing

Advantage Plus IEEE 841					
TYPE	AEHH8B		CAT. NO.	APH06045-841	
OUTPUT	60 HP 44.76 kW		FRAME	364T	TEFC
R.P.M.	1775		POLE	4	INS. F
VOLTS	575		PHASE	3	Hz 60
AMPS	54.7		CODE	G	S.F. 1.15
AMBIENT	40 °C		NOM. EFF. 95		MIN. EFF. 94.1
BEARINGS	6313ZC3 / 6213ZC3				RATING Cont.
SER. NO.	TBD		DESIGN	B	WT. 873 LBS
PWM VFD DUTY	VT	CT	CP	S.F.	
	3-60Hz	6-60Hz	60-90Hz	1	



### Connection Diagram

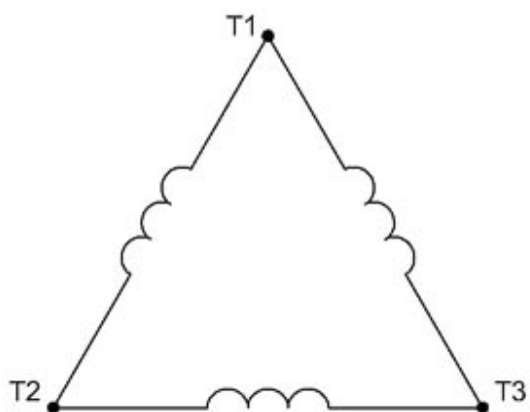

3 LEAD SINGLE VOLTAGE DELTA					
VOLTAGE	CONN.	L1	L2	L3	
-	DELTA	1	2	3	

WD\_3D



### Thermal Limit Curves

Motor Type: AEHH8B		Catalogue No: APH06045-841		Family: Advantage Plus IEEE 841	
HP	60	Safe Stall Time		Full Load A	54.7 A
Voltage	575V 60Hz	Hot	12 s	% Inrush	636 %
RPM	1800	Cold	17 s	Locked Rotor A	348 A

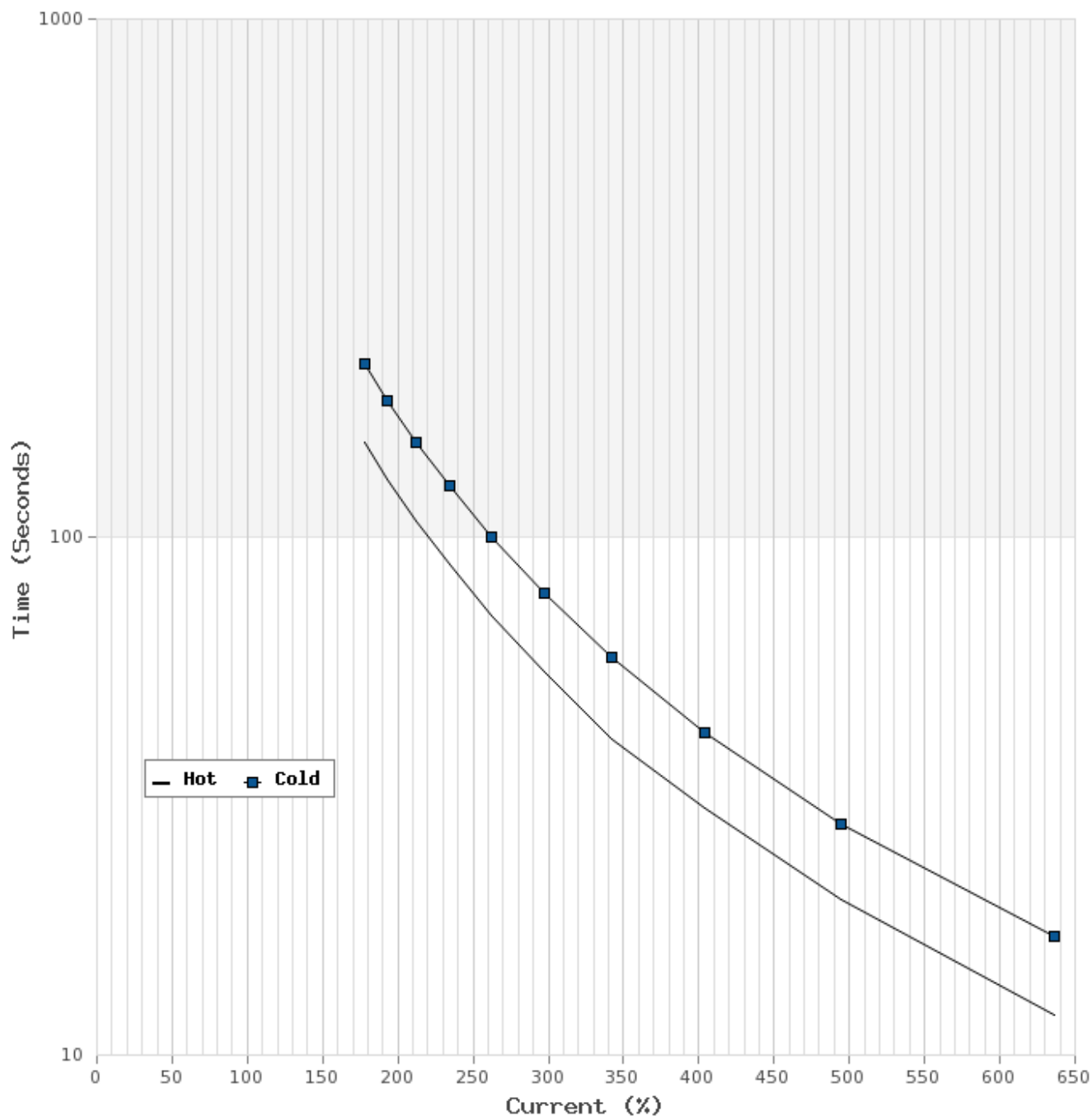



**T-N and I-N Curves**

Motor Type: AEHH8B		Catalogue No: APH06045-841		Family: Advantage Plus IEEE 841	
HP	60	Full Load T	177.5 lb-ft	Full Load A	54.7 A
Voltage	575V 60Hz	Locked Rotor T	200 %	Locked Rotor A	348.0 A
RPM	1800	Pull Up T	155 %	Break Down T	240 %

