



Technical Documentation

APH03045-841

Advantage Plus IEEE 841 | AEHH8B

Beaver Electrical Machinery Ltd.

Date: July 25, 2022



Dimensional Drawing

Catalogue	Type	HP	RPM	Voltage	Hz	Frame Size
APH03045-841	AEHH8B	30	1800	575	60	286T

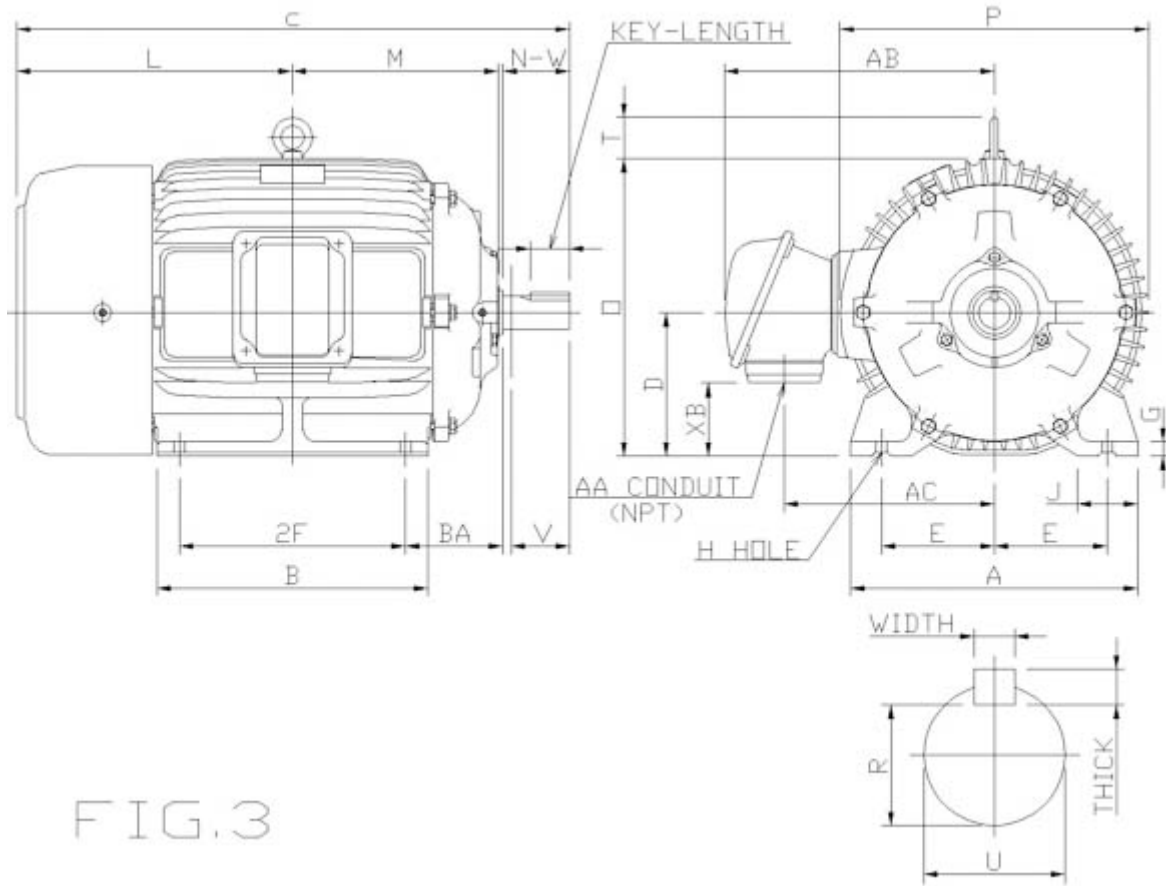

FIG.3



Mounting					A	B	C	CL1	CL2	D	G
E	2F1	2F2	H	BA							
5.5	11	9.5	0.53	4.75	13.98	13.19	28.3			7	0.7

J	K	L	M	O	P	T
2.95		13.43	9.98	14.5	15.05	2.36

Terminal Housing			
AA	AB	AC	XB
NPT11/2"	13.27	10.35	3.54

Shaft Extension			Key			Keyseat
N-W	U	V	Width	Thick	Length	R
4.62	1.875	4.5	0.5	0.5	3.28	1.591

Bearings		Weight Lbs	Drive Method	Dimensions
DE	NDE			
6311ZC3	6310ZC3	517	Direct Coupling / Belt Drive	Inches

	Beaver Electrical Machinery Ltd.	
	Date: July 25, 2022	

Technical Data Sheet

Motor Type: AEHH8B	Catalogue No: APH03045-841
--------------------	----------------------------

Nameplate Information

HP	Pole	RPM	Frame	Voltage	Hz	Phase
30	4	1765	286T	575	60	3
Enclosure	Ins. Class	Service Factor	Time Rating	NEMA Design	Rated Amb.	Rated Altitude
TEFC	F	1.15	Continuous	B	-40 to 40 °C	<1000 m

Typical Performance

Efficiency (%)				Power Factor (%)		
Full Load		3/4 Load	1/2 Load	Full Load	3/4 Load	1/2 Load
Nom.	Min.					
93.6	92.4	93.6	93.6	87.5	85.5	79.5
Torque				Current (A)		
Full Load (lb-ft)	Locked Rotor (% FLT)	Pull Up (% FLT)	Break Down (% FLT)	No Load	Full Load	Locked Rotor
88.99	200	160	235	7.0	27.4	174.4
NEMA KVA Code	Inertia (WR ²)			Safe Stall Time (s)		Noise Level Sound Press. dB(A)
	Rotor (lb-ft ²)	NEMA Load (lb-ft ²)	Max. Allowable (lb-ft ²)	Cold	Hot	
G	5.274	144	328	25	18	70

VFD Duty Information

Max HP	Current (A)	Speed Range		VFD		S.F.
		Constant Torque	Variable Torque	Carrier Hz	Type	
30	27.44	6-60Hz	3-60Hz	3-6kHz	VPWM or CPWM	1

Hazardous Locations Information



CSA Certified
Class I, Div 2, Groups B, C & D Class I, Zone 2, Groups IIB+H2, IIB & IIA
Temp Code (Sinewave / VFD) T3C / T3B

Additional Certifications

Other Certification

Additional Information

Bearings		Approx. Weight
DE	NDE	lbs
6311ZC3	6310ZC3	517

	Beaver Electrical Machinery Ltd.	
	Date: July 25, 2022	

Nameplate Drawing

Advantage Plus IEEE 841					
TYPE	AEHH8B	CAT. NO.	APH03045-841		
OUTPUT	30 HP 22.38 kW	FRAME	286T	TEFC	
R.P.M.	1765	POLE	4	INS.	F
VOLTS	575	PHASE	3	Hz	60
AMPS	27.4	CODE	G	S.F.	1.15
AMBIENT	40 °C	NOM. EFF. 93.6		MIN. EFF. 92.4	
BEARINGS	6311ZC3 / 6310ZC3			RATING Cont.	
SER. NO.	TBD	DESIGN	B	WT. 517 LBS	
PWM VFD DUTY	VT	CT	CP	S.F.	
	3-60Hz	6-60Hz	60-90Hz	1	



Connection Diagram

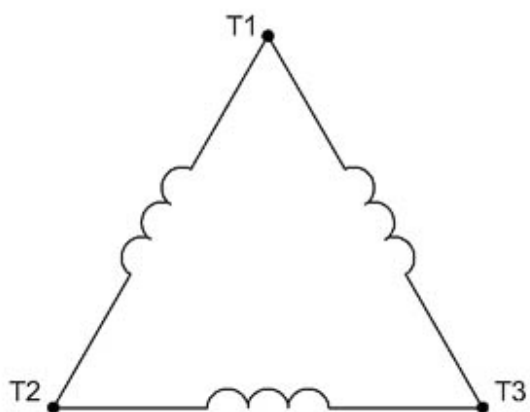

3 LEAD SINGLE VOLTAGE DELTA					
VOLTAGE	CONN.	L1	L2	L3	
-	DELTA	1	2	3	

WD_3D



Thermal Limit Curves

Motor Type: AEHH8B		Catalogue No: APH03045-841		Family: Advantage Plus IEEE 841	
HP	30	Safe Stall Time		Full Load A	27.4 A
Voltage	575V 60Hz	Hot	18 s	% Inrush	636 %
RPM	1800	Cold	25 s	Locked Rotor A	174.4 A

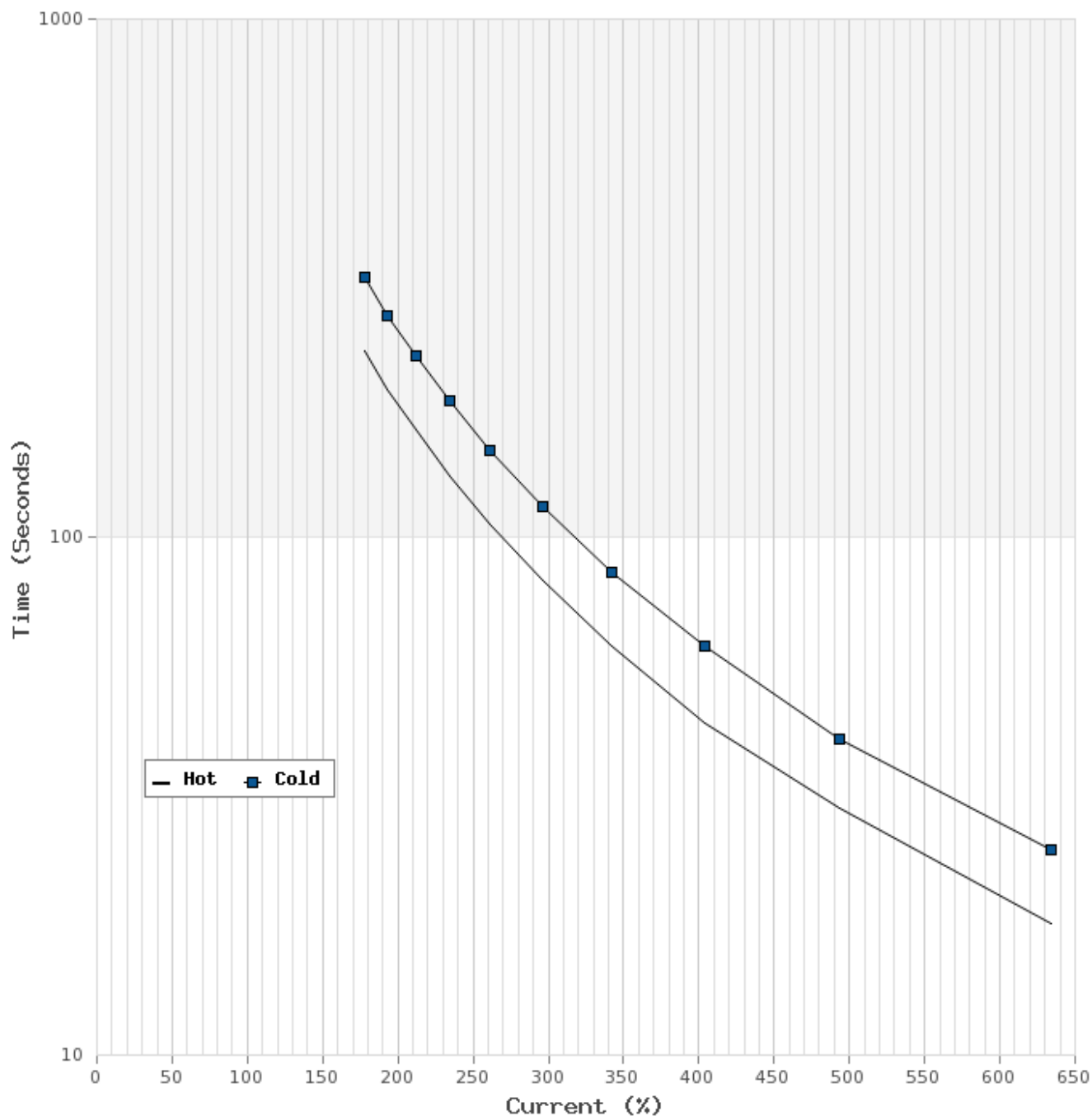



T-N and I-N Curves

Motor Type: AEHH8B		Catalogue No: APH03045-841		Family: Advantage Plus IEEE 841	
HP	30	Full Load T	88.99 lb-ft	Full Load A	27.4 A
Voltage	575V 60Hz	Locked Rotor T	200 %	Locked Rotor A	174.4 A
RPM	1800	Pull Up T	160 %	Break Down T	235 %

