



Technical Documentation

APH02085-841

Advantage Plus IEEE 841 | AEHH8B

Beaver Electrical Machinery Ltd.

Date: July 25, 2022



Dimensional Drawing

Catalogue	Type	HP	RPM	Voltage	Hz	Frame Size
APH02085-841	AEHH8B	20	900	575	60	324T

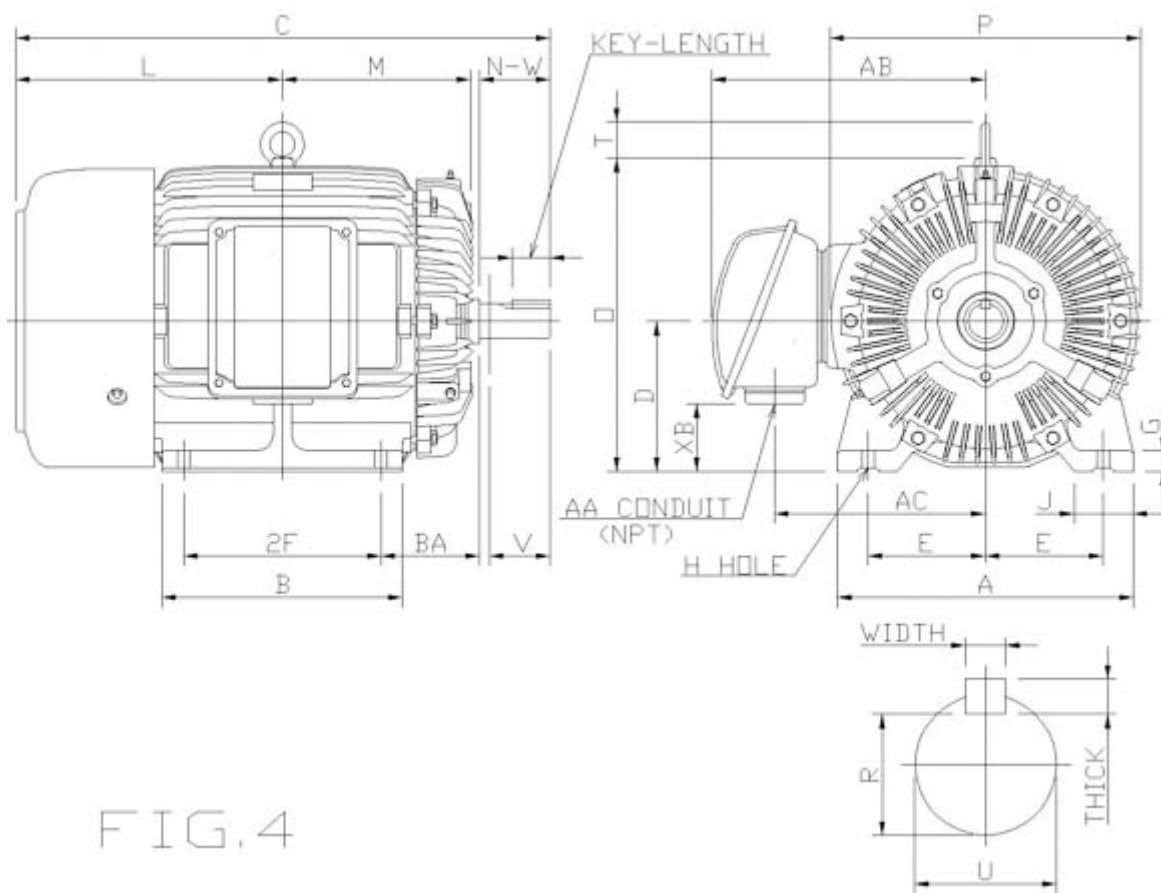



Mounting					A	B	C	CL1	CL2	D	G
E	2F1	2F2	H	BA							
6.25	10.5		0.66	5.25	15.75	12.8	29.93			8	1.1

J	K	L	M	O	P	T
3.15		14.18	10.1	16.22	16.55	2.36

Terminal Housing			
AA	AB	AC	XB
NPT2"	14.72	11.3	3.59

Shaft Extension			Key			Keyseat
N-W	U	V	Width	Thick	Length	R
5.25	2.125	5.15	0.5	0.5	3.91	1.845

Bearings		Weight Lbs	Drive Method	Dimensions
DE	NDE			
6312ZC3	6212ZC3	629	Direct Coupling / Belt Drive	Inches

	Beaver Electrical Machinery Ltd.	
	Date: July 25, 2022	

Technical Data Sheet

Motor Type: AEHH8B	Catalogue No: APH02085-841
--------------------	----------------------------

Nameplate Information

HP	Pole	RPM	Frame	Voltage	Hz	Phase
20	8	875	324T	575	60	3
Enclosure	Ins. Class	Service Factor	Time Rating	NEMA Design	Rated Amb.	Rated Altitude
TEFC	F	1.15	Continuous	B	-40 to 40 °C	<1000 m

Typical Performance

Efficiency (%)				Power Factor (%)		
Full Load		3/4 Load	1/2 Load	Full Load	3/4 Load	1/2 Load
Nom.	Min.					
90.2	88.5	91	91	81	76	67
Torque				Current (A)		
Full Load (lb-ft)	Locked Rotor (% FLT)	Pull Up (% FLT)	Break Down (% FLT)	No Load	Full Load	Locked Rotor
120	200	170	210	8.5	20.5	116
NEMA KVA Code	Inertia (WR ²)			Safe Stall Time (s)		Noise Level Sound Press. dB(A)
	Rotor (lb-ft ²)	NEMA Load (lb-ft ²)	Max. Allowable (lb-ft ²)	Cold	Hot	
G	10.393	525	1001	36	25	65

VFD Duty Information

Max HP	Current (A)	Speed Range		VFD		S.F.
		Constant Torque	Variable Torque	Carrier Hz	Type	
20	20.51	6-60Hz	3-60Hz	3-6kHz	VPWM or CPWM	1

Hazardous Locations Information



CSA Certified
Class I, Div 2, Groups B, C & D Class I, Zone 2, Groups IIB+H2, IIB & IIA
Temp Code (Sinewave / VFD) T3A / T3A

Additional Certifications

Other Certification

Additional Information

Bearings		Approx. Weight
DE	NDE	lbs
6312ZC3	6212ZC3	629

	Beaver Electrical Machinery Ltd.	
	Date: July 25, 2022	

Nameplate Drawing

Advantage Plus IEEE 841					
TYPE	AEHH8B		CAT. NO.	APH02085-841	
OUTPUT	20 HP	14.92 kW	FRAME	324T	TEFC
R.P.M.	875		POLE	8	INS. F
VOLTS	575		PHASE	3	Hz 60
AMPS	20.5		CODE	G	S.F. 1.15
AMBIENT	40 °C		NOM. EFF. 90.2		MIN. EFF. 88.5
BEARINGS	6312ZC3 / 6212ZC3				RATING Cont.
SER. NO.	TBD		DESIGN	B	WT. 629 LBS
PWM VFD DUTY	VT	CT	CP	S.F.	
	3-60Hz	6-60Hz	60-120Hz	1	



Connection Diagram

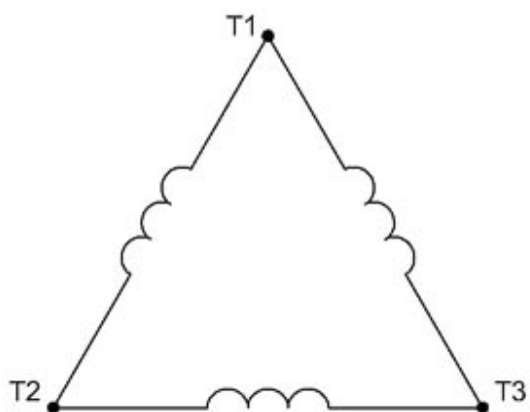

3 LEAD SINGLE VOLTAGE DELTA					
VOLTAGE	CONN.	L1	L2	L3	
-	DELTA	1	2	3	

WD_3D



Thermal Limit Curves

Motor Type: AEHH8B		Catalogue No: APH02085-841		Family: Advantage Plus IEEE 841	
HP	20	Safe Stall Time		Full Load A	20.5 A
Voltage	575V 60Hz	Hot	25 s	% Inrush	566 %
RPM	900	Cold	36 s	Locked Rotor A	116 A

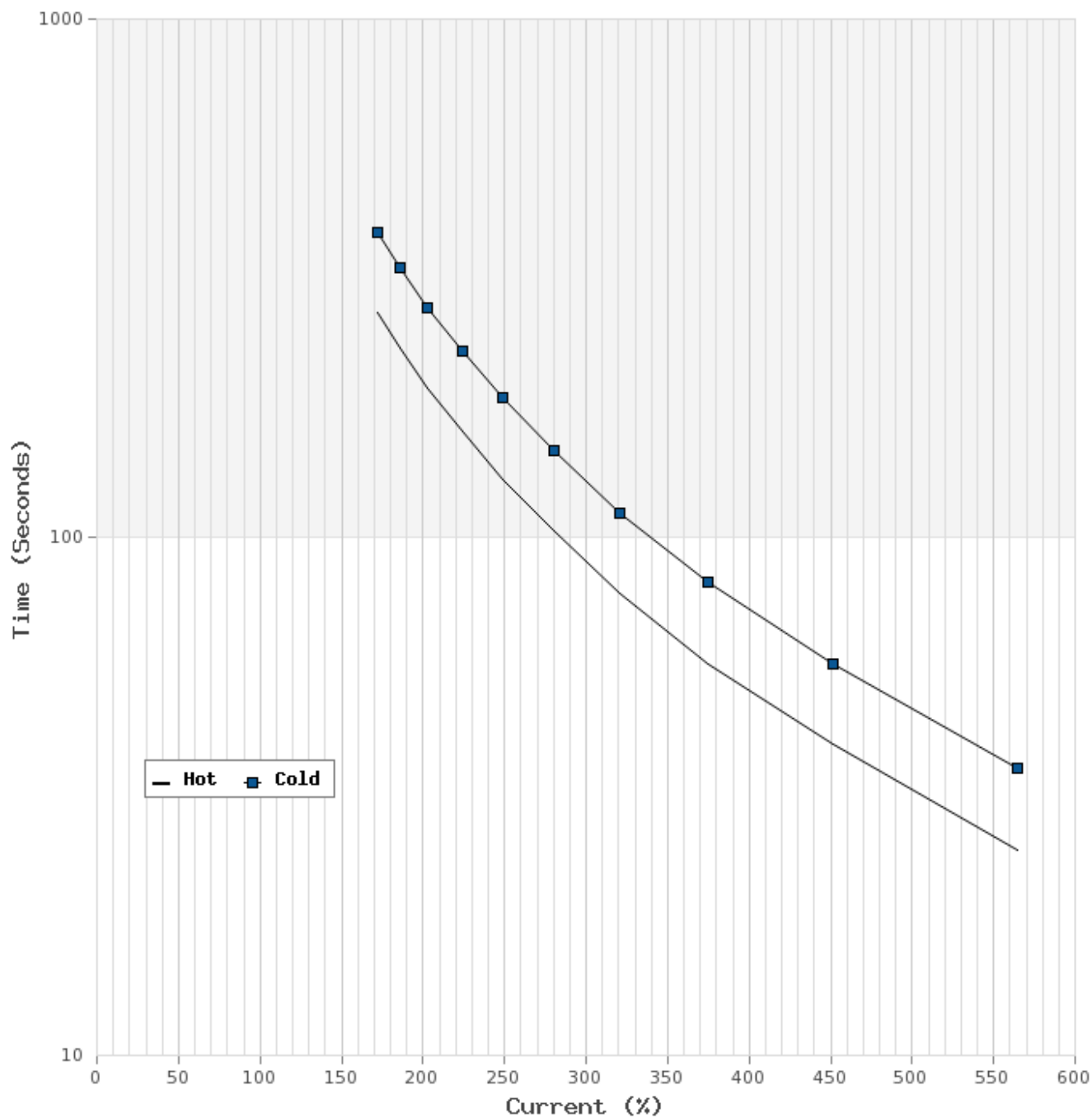



T-N and I-N Curves

Motor Type: AEHH8B		Catalogue No: APH02085-841		Family: Advantage Plus IEEE 841	
HP	20	Full Load T	120 lb-ft	Full Load A	20.5 A
Voltage	575V 60Hz	Locked Rotor T	200 %	Locked Rotor A	116.0 A
RPM	900	Pull Up T	170 %	Break Down T	210 %

