



Technical Documentation

APH01565-841

Advantage Plus IEEE 841 | AEHH8B

Beaver Electrical Machinery Ltd.

Date: July 25, 2022



Dimensional Drawing

Catalogue	Type	HP	RPM	Voltage	Hz	Frame Size
APH01565-841	AEHH8B	15	1200	575	60	284T

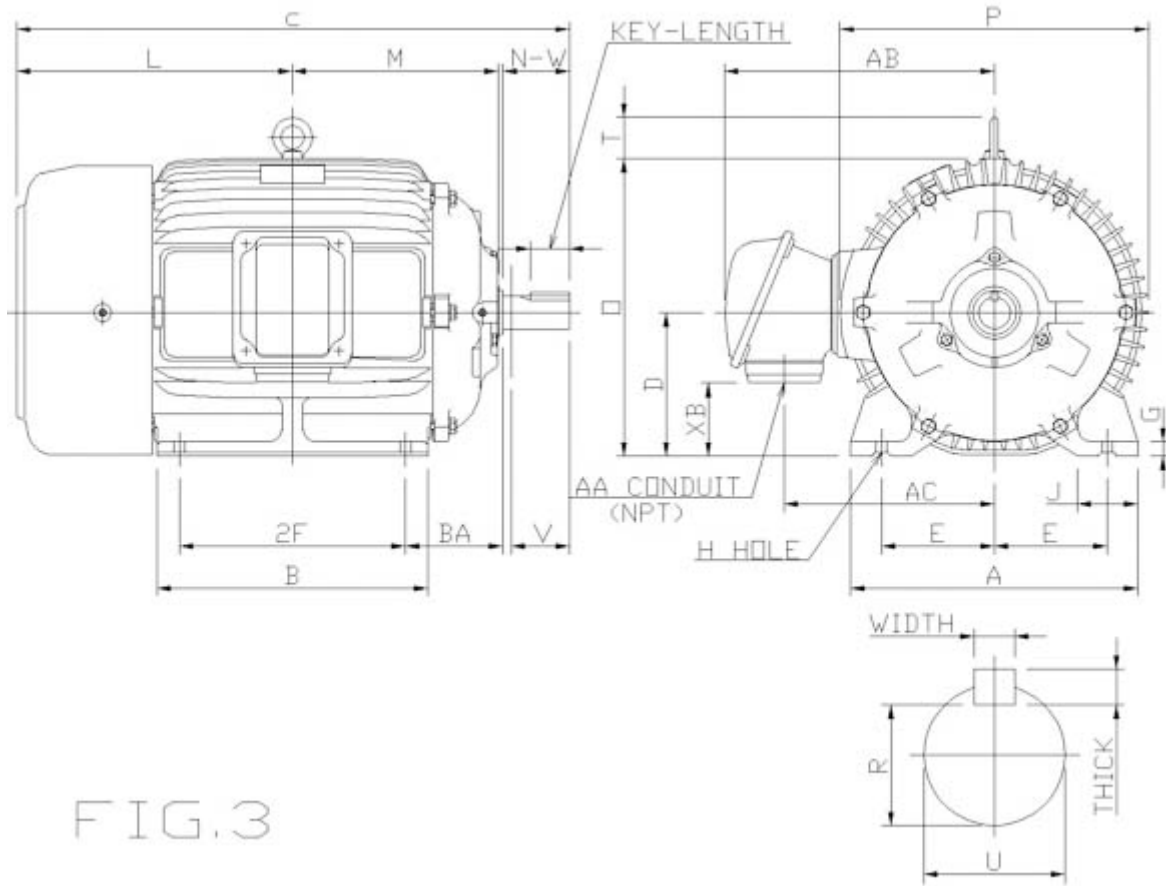

FIG.3



Mounting					A	B	C	CL1	CL2	D	G
E	2F1	2F2	H	BA							
5.5	9.5		0.53	4.75	13.98	11.69	26.8			7	0.7

J	K	L	M	O	P	T
2.95		12.68	9.23	14.5	15.05	2.36

Terminal Housing			
AA	AB	AC	XB
NPT11/2"	13.27	10.35	3.54

Shaft Extension			Key			Keyseat
N-W	U	V	Width	Thick	Length	R
4.62	1.875	4.5	0.5	0.5	3.28	1.591

Bearings		Weight Lbs	Drive Method	Dimensions
DE	NDE			
6311ZC3	6310ZC3	449	Direct Coupling / Belt Drive	Inches

	Beaver Electrical Machinery Ltd.	
	Date: July 25, 2022	

Technical Data Sheet

Motor Type: AEHH8B	Catalogue No: APH01565-841
--------------------	----------------------------

Nameplate Information

HP	Pole	RPM	Frame	Voltage	Hz	Phase
15	6	1175	284T	575	60	3
Enclosure	Ins. Class	Service Factor	Time Rating	NEMA Design	Rated Amb.	Rated Altitude
TEFC	F	1.15	Continuous	B	-40 to 40 °C	<1000 m

Typical Performance

Efficiency (%)				Power Factor (%)		
Full Load		3/4 Load	1/2 Load	Full Load	3/4 Load	1/2 Load
Nom.	Min.					
92.4	91	93	93	83.5	79.5	70.5
Torque				Current (A)		
Full Load (lb-ft)	Locked Rotor (% FLT)	Pull Up (% FLT)	Break Down (% FLT)	No Load	Full Load	Locked Rotor
67.03	215	180	230	5.3	14.6	92.8
NEMA KVA Code	Inertia (WR ²)			Safe Stall Time (s)		Noise Level Sound Press. dB(A)
	Rotor (lb-ft ²)	NEMA Load (lb-ft ²)	Max. Allowable (lb-ft ²)	Cold	Hot	
G	6.823	200	497	29	20	64

VFD Duty Information

Max HP	Current (A)	Speed Range		VFD		S.F.
		Constant Torque	Variable Torque	Carrier Hz	Type	
15	14.56	6-60Hz	3-60Hz	3-6kHz	VPWM or CPWM	1

Hazardous Locations Information



CSA Certified
Class I, Div 2, Groups B, C & D Class I, Zone 2, Groups IIB+H2, IIB & IIA
Temp Code (Sinewave / VFD) T3C / T3B

Additional Certifications

Other Certification

Additional Information

Bearings		Approx. Weight
DE	NDE	lbs
6311ZC3	6310ZC3	449

	Beaver Electrical Machinery Ltd.	
	Date: July 25, 2022	

Nameplate Drawing

Advantage Plus IEEE 841					
TYPE	AEHH8B		CAT. NO.	APH01565-841	
OUTPUT	15 HP 11.19 kW		FRAME	284T	TEFC
R.P.M.	1175		POLE	6	INS. F
VOLTS	575		PHASE	3	Hz 60
AMPS	14.6		CODE	G	S.F. 1.15
AMBIENT	40 °C		NOM. EFF. 92.4		MIN. EFF. 91
BEARINGS	6311ZC3 / 6310ZC3				RATING Cont.
SER. NO.	TBD		DESIGN	B	WT. 449 LBS
PWM VFD DUTY	VT	CT	CP	S.F.	
	3-60Hz	6-60Hz	60-120Hz	1	



Connection Diagram

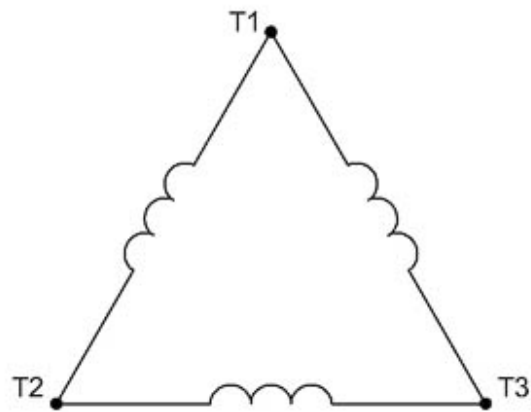

3 LEAD SINGLE VOLTAGE DELTA					
VOLTAGE	CONN.	L1	L2	L3	
-	DELTA	1	2	3	

WD_3D



Thermal Limit Curves

Motor Type: AEHH8B		Catalogue No: APH01565-841		Family: Advantage Plus IEEE 841	
HP	15	Safe Stall Time		Full Load A	14.6 A
Voltage	575V 60Hz	Hot	20 s	% Inrush	637 %
RPM	1200	Cold	29 s	Locked Rotor A	92.8 A

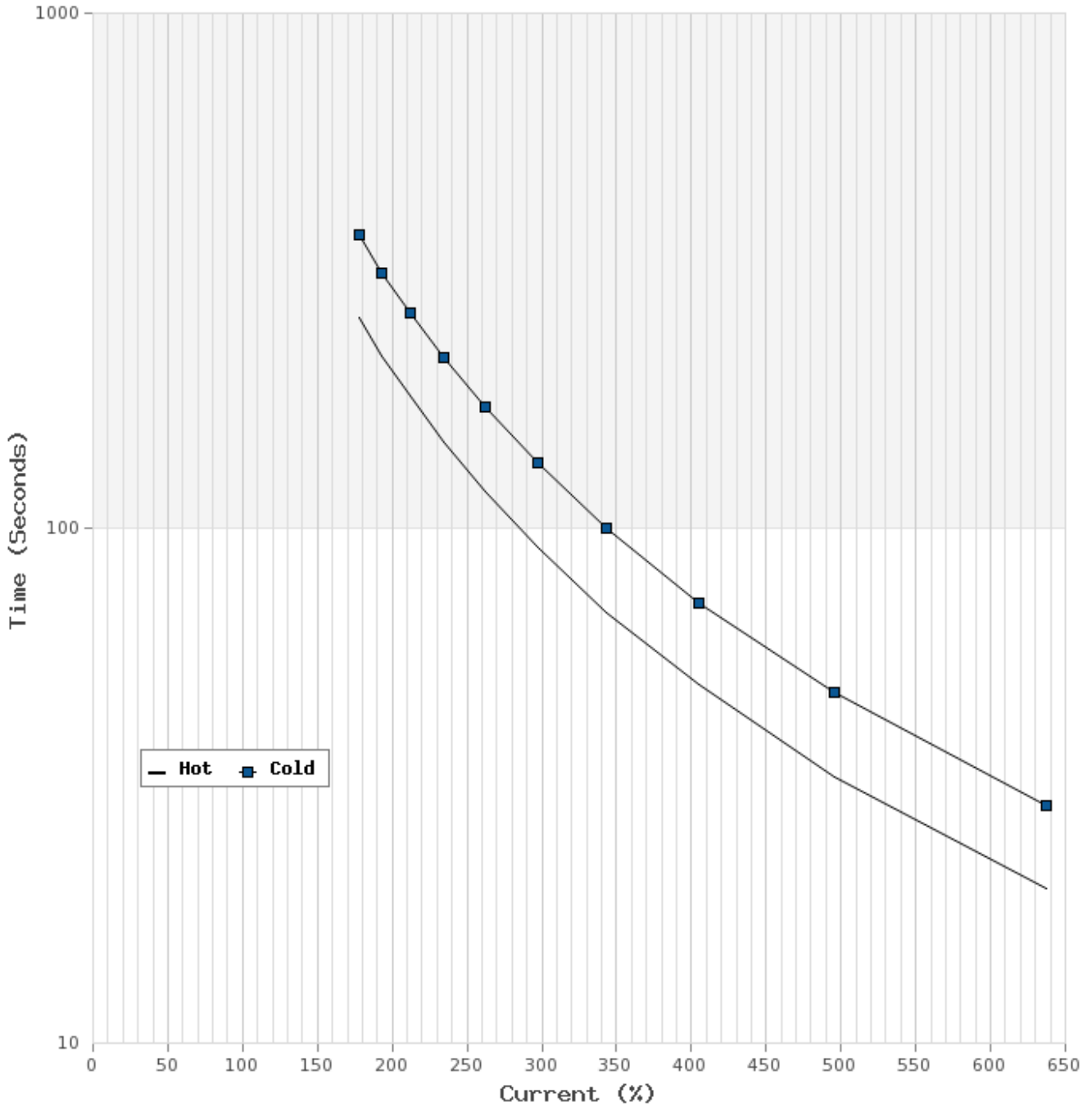



T-N and I-N Curves

Motor Type: AEHH8B		Catalogue No: APH01565-841		Family: Advantage Plus IEEE 841	
HP	15	Full Load T	67.03 lb-ft	Full Load A	14.6 A
Voltage	575V 60Hz	Locked Rotor T	215 %	Locked Rotor A	92.8 A
RPM	1200	Pull Up T	180 %	Break Down T	230 %

