



Technical Documentation

APH01525-841

Advantage Plus IEEE 841 | AEHH8B

Beaver Electrical Machinery Ltd.

Date: July 25, 2022



Dimensional Drawing

Catalogue	Type	HP	RPM	Voltage	Hz	Frame Size
APH01525-841	AEHH8B	15	3600	575	60	254T

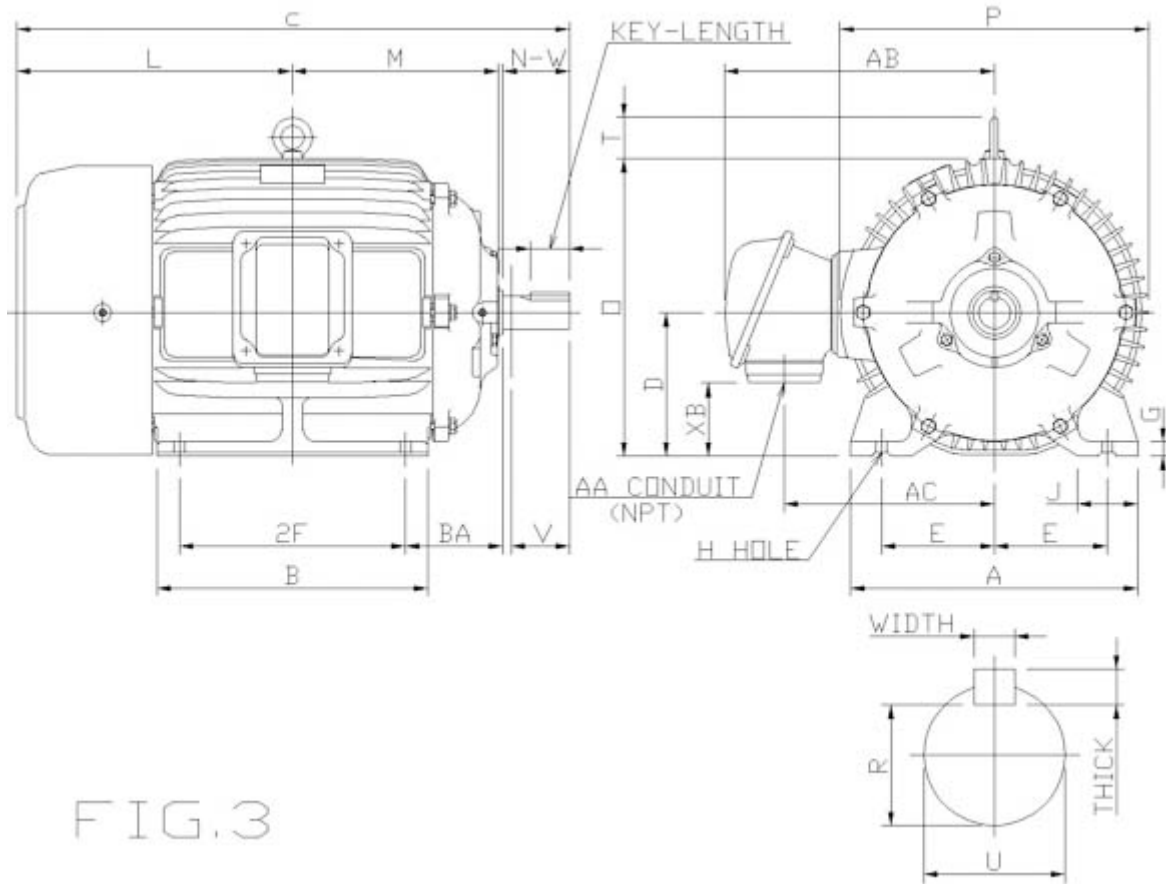

FIG.3



Mounting					A	B	C	CL1	CL2	D	G
E	2F1	2F2	H	BA							
5	8.25		0.53	4.25	11.81	9.85	23.78			6.25	0.66

J	K	L	M	O	P	T
1.95		11.41	8.06	12.8	13.15	2.01

Terminal Housing			
AA	AB	AC	XB
NPT11/4"	11.3	8.86	3.22

Shaft Extension			Key			Keyseat
N-W	U	V	Width	Thick	Length	R
4	1.625	3.9	0.375	0.375	2.91	1.416

Bearings		Weight Lbs	Drive Method	Dimensions
DE	NDE			
6309ZC3	6307C3	301	Direct Coupling / Belt Drive	Inches

	Beaver Electrical Machinery Ltd.	
	Date: July 25, 2022	

Technical Data Sheet

Motor Type: AEHH8B	Catalogue No: APH01525-841
--------------------	----------------------------

Nameplate Information

HP	Pole	RPM	Frame	Voltage	Hz	Phase
15	2	3525	254T	575	60	3
Enclosure	Ins. Class	Service Factor	Time Rating	NEMA Design	Rated Amb.	Rated Altitude
TEFC	F	1.15	Continuous	B	-40 to 40 °C	<1000 m

Typical Performance

Efficiency (%)				Power Factor (%)		
Full Load		3/4 Load	1/2 Load	Full Load	3/4 Load	1/2 Load
Nom.	Min.					
92.4	91	92.4	91.7	91.5	90.5	86
Torque				Current (A)		
Full Load (lb-ft)	Locked Rotor (% FLT)	Pull Up (% FLT)	Break Down (% FLT)	No Load	Full Load	Locked Rotor
22.34	210	180	270	3.0	13.3	92.8
NEMA KVA Code	Inertia (WR ²)			Safe Stall Time (s)		Noise Level Sound Press. dB(A)
	Rotor (lb-ft ²)	NEMA Load (lb-ft ²)	Max. Allowable (lb-ft ²)	Cold	Hot	
G	1.088	16	41	17	12	73

VFD Duty Information

Max HP	Current (A)	Speed Range		VFD		S.F.
		Constant Torque	Variable Torque	Carrier Hz	Type	
15	13.29	6-60Hz	3-60Hz	3-6kHz	VPWM or CPWM	1

Hazardous Locations Information



CSA Certified
Class I, Div 2, Groups B, C & D Class I, Zone 2, Groups IIB+H2, IIB & IIA
Temp Code (Sinewave / VFD) T3C / T3B

Additional Certifications

Other Certification

Additional Information

Bearings		Approx. Weight
DE	NDE	lbs
6309ZC3	6307C3	301

	Beaver Electrical Machinery Ltd.	
	Date: July 25, 2022	

Nameplate Drawing

Advantage Plus IEEE 841					
TYPE	AEHH8B		CAT. NO.	APH01525-841	
OUTPUT	15 HP 11.19 kW		FRAME	254T	TEFC
R.P.M.	3525		POLE	2	INS. F
VOLTS	575		PHASE	3	Hz 60
AMPS	13.3		CODE	G	S.F. 1.15
AMBIENT	40 °C		NOM. EFF. 92.4		MIN. EFF. 91
BEARINGS	6309ZC3 / 6307C3				RATING Cont.
SER. NO.	TBD		DESIGN	B	WT. 301 LBS
PWM VFD DUTY	VT	CT	CP	S.F.	
	3-60Hz	6-60Hz	60-90Hz	1	



Connection Diagram

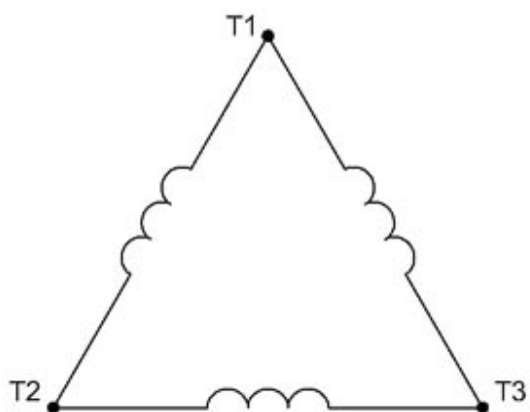

3 LEAD SINGLE VOLTAGE DELTA					
VOLTAGE	CONN.	L1	L2	L3	
-	DELTA	1	2	3	

WD_3D



Thermal Limit Curves

Motor Type: AEHH8B		Catalogue No: APH01525-841		Family: Advantage Plus IEEE 841	
HP	15	Safe Stall Time		Full Load A	13.3 A
Voltage	575V 60Hz	Hot	12 s	% Inrush	698 %
RPM	3600	Cold	17 s	Locked Rotor A	92.8 A

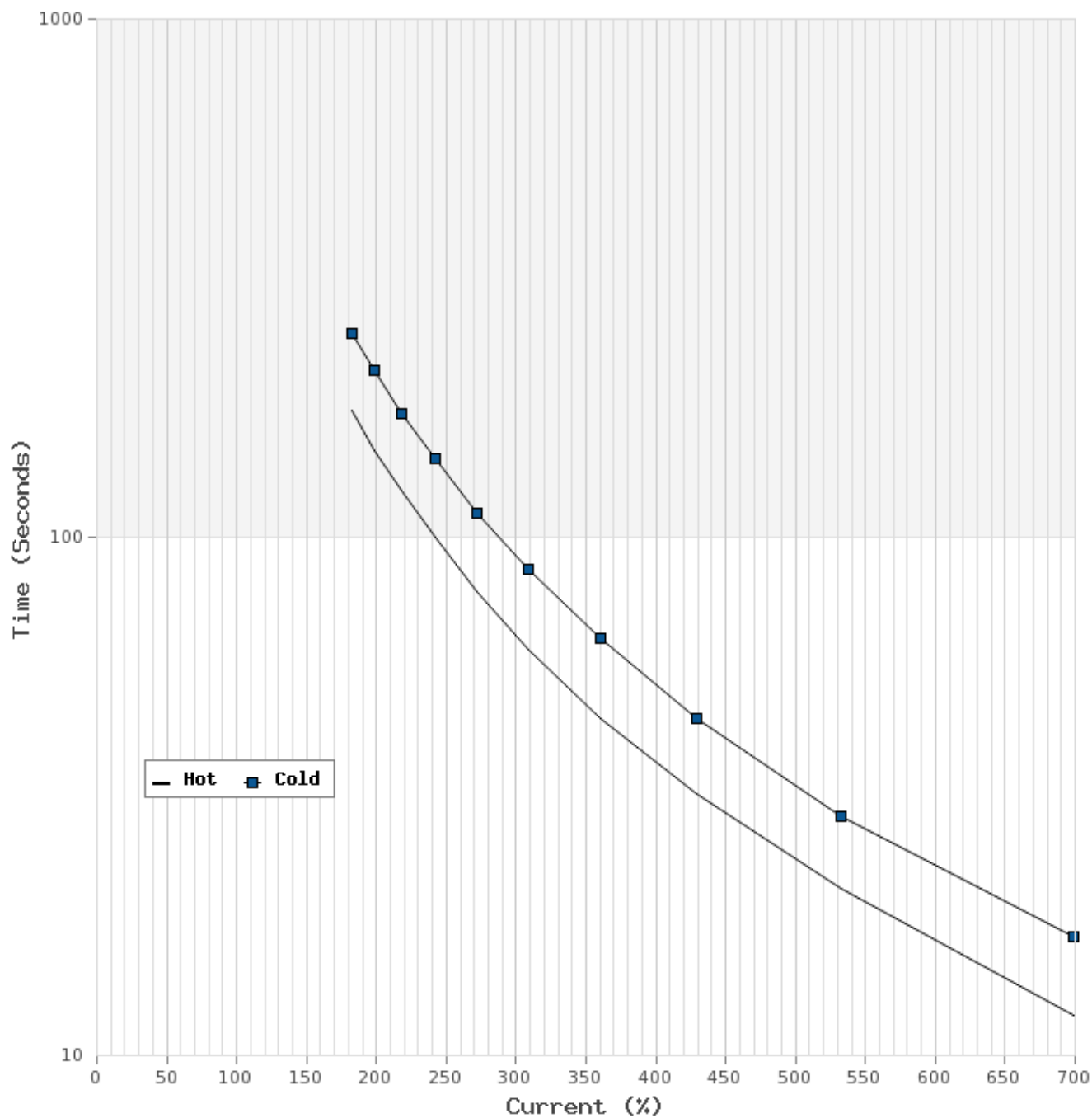



T-N and I-N Curves

Motor Type: AEHH8B		Catalogue No: APH01525-841		Family: Advantage Plus IEEE 841	
HP	15	Full Load T	22.34 lb-ft	Full Load A	13.3 A
Voltage	575V 60Hz	Locked Rotor T	210 %	Locked Rotor A	92.8 A
RPM	3600	Pull Up T	180 %	Break Down T	270 %

