



Technical Documentation

APH00565-841

Advantage Plus IEEE 841 | AEHH8B

Beaver Electrical Machinery Ltd.

Date: July 25, 2022



Dimensional Drawing

Catalogue	Type	HP	RPM	Voltage	Hz	Frame Size
APH00565-841	AEHH8B	5	1200	575	60	215T

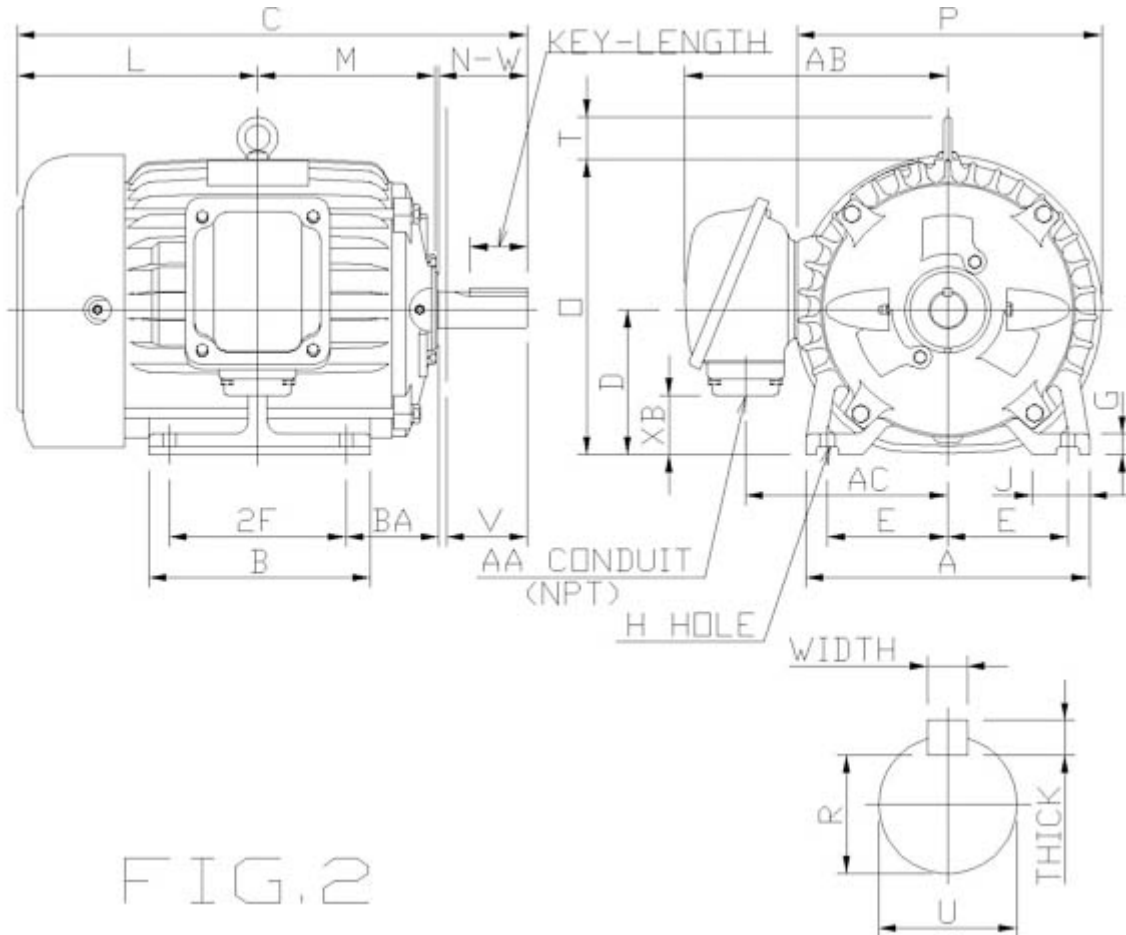



Mounting					A	B	C	CL1	CL2	D	G
E	2F1	2F2	H	BA							
4.25	7	5.5	0.41	3.5	9.85	8.35	19.76			5.25	0.7

J	K	L	M	O	P	T
1.75		9.38	6.85	10.62	11.1	1.65

Terminal Housing			
AA	AB	AC	XB
NPT1"	9.78	7.34	2.34

Shaft Extension			Key			Keyseat
N-W	U	V	Width	Thick	Length	R
3.38	1.375	3.3	0.312	0.312	2.41	1.201

Bearings		Weight Lbs	Drive Method	Dimensions
DE	NDE			
6308ZC3	6306ZC3	196	Direct Coupling / Belt Drive	Inches

	Beaver Electrical Machinery Ltd.	
	Date: July 25, 2022	

Technical Data Sheet

Motor Type: AEHH8B	Catalogue No: APH00565-841
--------------------	----------------------------

Nameplate Information

HP	Pole	RPM	Frame	Voltage	Hz	Phase
5	6	1170	215T	575	60	3
Enclosure	Ins. Class	Service Factor	Time Rating	NEMA Design	Rated Amb.	Rated Altitude
TEFC	F	1.15	Continuous	B	-40 to 40 °C	<1000 m

Typical Performance

Efficiency (%)				Power Factor (%)		
Full Load		3/4 Load	1/2 Load	Full Load	3/4 Load	1/2 Load
Nom.	Min.					
91	89.5	91	89.5	82.5	77	65.5
Torque				Current (A)		
Full Load (lb-ft)	Locked Rotor (% FLT)	Pull Up (% FLT)	Break Down (% FLT)	No Load	Full Load	Locked Rotor
22.44	190	160	300	2.3	5.0	36.8
NEMA KVA Code	Inertia (WR ²)			Safe Stall Time (s)		Noise Level Sound Press. dB(A)
	Rotor (lb-ft ²)	NEMA Load (lb-ft ²)	Max. Allowable (lb-ft ²)	Cold	Hot	
J	1.224	71	416	68	48	55

VFD Duty Information

Max HP	Current (A)	Speed Range		VFD		S.F.
		Constant Torque	Variable Torque	Carrier Hz	Type	
5	4.99	6-60Hz	3-60Hz	3-6kHz	VPWM or CPWM	1

Hazardous Locations Information



CSA Certified	
Class I, Div 2, Groups B, C & D Class I, Zone 2, Groups IIB+H2, IIB & IIA	
Temp Code (Sinewave / VFD)	T4 / T4

Additional Certifications

Other Certification

Additional Information

Bearings		Approx. Weight
DE	NDE	lbs
6308ZC3	6306ZC3	196

	Beaver Electrical Machinery Ltd.	
	Date: July 25, 2022	

Nameplate Drawing

Advantage Plus IEEE 841					
TYPE	AEHH8B	CAT. NO.	APH00565-841		
OUTPUT	5 HP 3.73 kW	FRAME	215T	TEFC	
R.P.M.	1170	POLE	6	INS.	F
VOLTS	575	PHASE	3	Hz	60
AMPS	5.0	CODE	J	S.F.	1.15
AMBIENT	40 °C	NOM. EFF. 91		MIN. EFF. 89.5	
BEARINGS	6308ZC3 / 6306ZC3			RATING Cont.	
SER. NO.	TBD	DESIGN	B	WT. 196 LBS	
PWM VFD DUTY	VT	CT	CP	S.F.	
	3-60Hz	6-60Hz	60-120Hz	1	



Connection Diagram

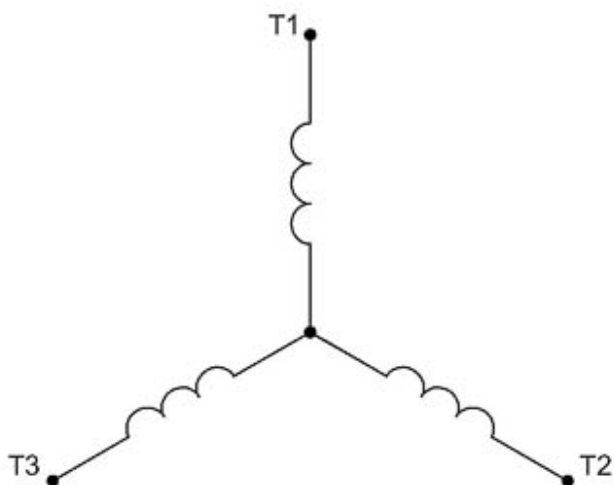

3 LEAD		SINGLE VOLTAGE			WYE
VOLTAGE	CONN.	L1	L2	L3	
-	WYE	1	2	3	

WD_3Y



Thermal Limit Curves

Motor Type: AEHH8B		Catalogue No: APH00565-841		Family: Advantage Plus IEEE 841	
HP	5	Safe Stall Time		Full Load A	5.0 A
Voltage	575V 60Hz	Hot	48 s	% Inrush	737 %
RPM	1200	Cold	68 s	Locked Rotor A	36.8 A

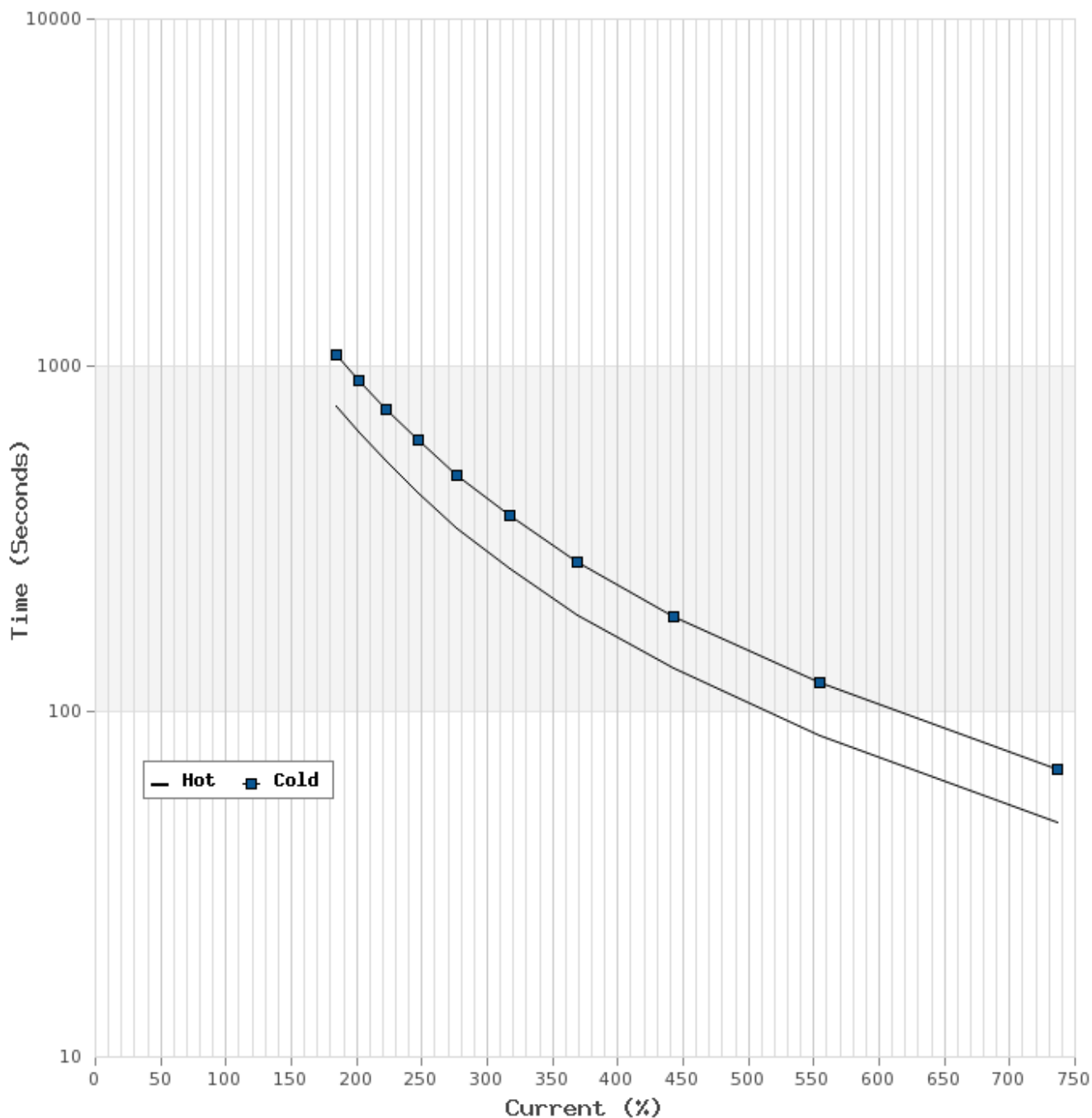



T-N and I-N Curves

Motor Type: AEHH8B		Catalogue No: APH00565-841		Family: Advantage Plus IEEE 841	
HP	5	Full Load T	22.44 lb-ft	Full Load A	5.0 A
Voltage	575V 60Hz	Locked Rotor T	190 %	Locked Rotor A	36.8 A
RPM	1200	Pull Up T	160 %	Break Down T	300 %

