



Technical Documentation

# **APH00545-841**

## **Advantage Plus IEEE 841 | AEHH8B**

Beaver Electrical Machinery Ltd.

Date: July 25, 2022



**Dimensional Drawing**

Catalogue	Type	HP	RPM	Voltage	Hz	Frame Size
APH00545-841	AEHH8B	5	1800	575	60	184T

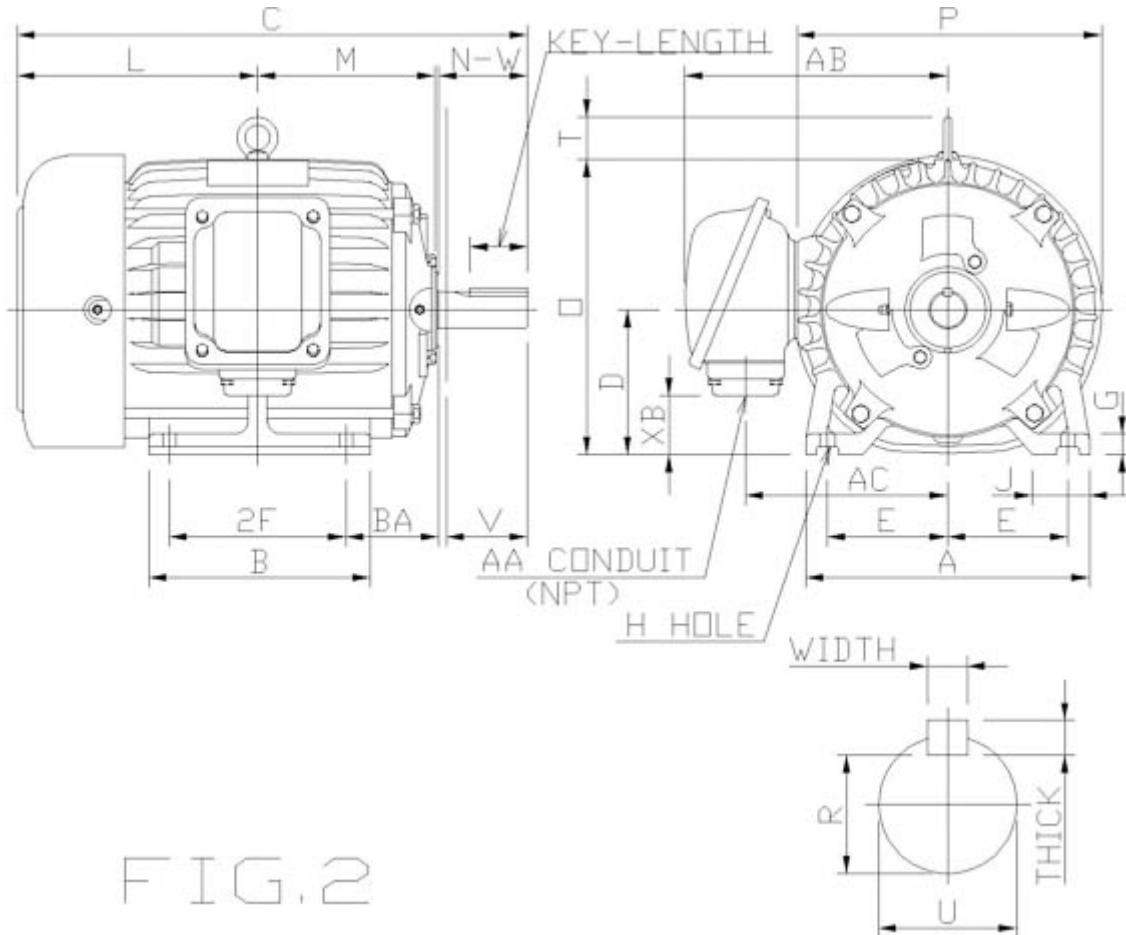

FIG. 2



Mounting					A	B	C	CL1	CL2	D	G
E	2F1	2F2	H	BA							
3.75	5.5	4.5	0.41	2.75	8.82	6.89	15.91			4.5	0.65

J	K	L	M	O	P	T
1.75		7.66	5.37	9.17	9.61	1.3

Terminal Housing			
AA	AB	AC	XB
NPT3/4"	8.31	6.38	1.86

Shaft Extension			Key			Keyseat
N-W	U	V	Width	Thick	Length	R
2.75	1.125	2.7	0.25	0.25	1.78	0.986

Bearings		Weight Lbs	Drive Method	Dimensions
DE	NDE			
6306ZC3	6306ZC3	110	Direct Coupling / Belt Drive	Inches

	Beaver Electrical Machinery Ltd.	
	Date: July 25, 2022	

### Technical Data Sheet

Motor Type: AEHH8B	Catalogue No: APH00545-841
--------------------	----------------------------

#### Nameplate Information

HP	Pole	RPM	Frame	Voltage	Hz	Phase
5	4	1745	184T	575	60	3
Enclosure	Ins. Class	Service Factor	Time Rating	NEMA Design	Rated Amb.	Rated Altitude
TEFC	F	1.15	Continuous	B	-40 to 40 °C	<1000 m

#### Typical Performance

Efficiency (%)				Power Factor (%)		
Full Load		3/4 Load	1/2 Load	Full Load	3/4 Load	1/2 Load
Nom.	Min.					
89.5	87.5	88.5	88.5	85.5	81.5	71.5
Torque				Current (A)		
Full Load (lb-ft)	Locked Rotor (% FLT)	Pull Up (% FLT)	Break Down (% FLT)	No Load	Full Load	Locked Rotor
15.04	185	140	285	1.8	4.9	36.8
NEMA KVA Code	Inertia (WR <sup>2</sup> )			Safe Stall Time (s)		Noise Level Sound Press. dB(A)
	Rotor (lb-ft <sup>2</sup> )	NEMA Load (lb-ft <sup>2</sup> )	Max. Allowable (lb-ft <sup>2</sup> )	Cold	Hot	
J	0.422	27	88	35	25	54

#### VFD Duty Information

Max HP	Current (A)	Speed Range		VFD		S.F.
		Constant Torque	Variable Torque	Carrier Hz	Type	
5	4.89	6-60Hz	3-60Hz	3-6kHz	VPWM or CPWM	1

#### Hazardous Locations Information



CSA Certified
Class I, Div 2, Groups B, C & D Class I, Zone 2, Groups IIB+H2, IIB & IIA
Temp Code (Sinewave / VFD)
T3C / T3C

#### Additional Certifications

Other Certification
---------------------

#### Additional Information

Bearings		Approx. Weight
DE	NDE	lbs
6306ZC3	6306ZC3	110

	Beaver Electrical Machinery Ltd.	
	Date: July 25, 2022	

### Nameplate Drawing

Advantage Plus IEEE 841					
TYPE	AEHH8B		CAT. NO.	APH00545-841	
OUTPUT	5 HP 3.73 kW		FRAME	184T	TEFC
R.P.M.	1745		POLE	4	INS. F
VOLTS	575		PHASE	3	Hz 60
AMPS	4.9		CODE	J	S.F. 1.15
AMBIENT	40 °C		NOM. EFF. 89.5		MIN. EFF. 87.5
BEARINGS	6306ZC3 / 6306ZC3				RATING Cont.
SER. NO.	TBD		DESIGN	B	WT. 110 LBS
PWM VFD DUTY	VT	CT	CP	S.F.	
	3-60Hz	6-60Hz	60-120Hz	1	



### Connection Diagram

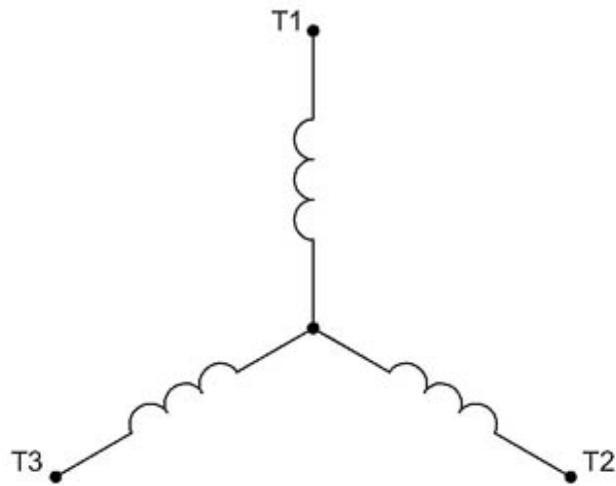

3 LEAD		SINGLE VOLTAGE			WYE
VOLTAGE	CONN.	L1	L2	L3	
-	WYE	1	2	3	

WD\_3Y



### Thermal Limit Curves

Motor Type: AEHH8B		Catalogue No: APH00545-841		Family: Advantage Plus IEEE 841	
HP	5	Safe Stall Time		Full Load A	4.9 A
Voltage	575V 60Hz	Hot	25 s	% Inrush	753 %
RPM	1800	Cold	35 s	Locked Rotor A	36.8 A

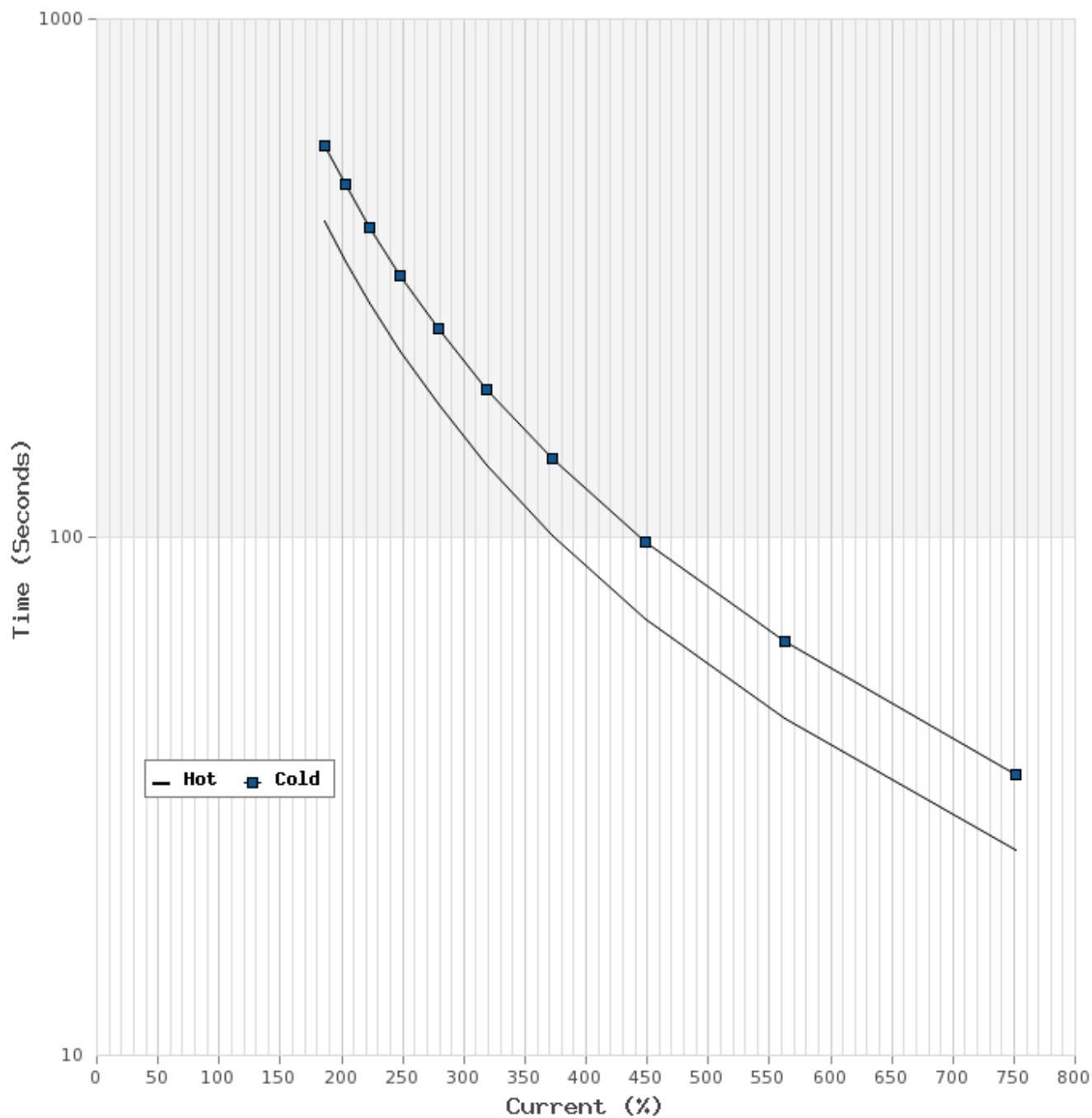



### T-N and I-N Curves

Motor Type: AEHH8B		Catalogue No: APH00545-841		Family: Advantage Plus IEEE 841	
HP	5	Full Load T	15.04 lb-ft	Full Load A	4.9 A
Voltage	575V 60Hz	Locked Rotor T	185 %	Locked Rotor A	36.8 A
RPM	1800	Pull Up T	140 %	Break Down T	285 %

