



Technical Documentation

# **APH0016-841**

## **Advantage Plus IEEE 841 | AEHH8B**

Beaver Electrical Machinery

Date: June 7, 2022



**Dimensional Drawing**

Catalogue	Type	HP	RPM	Voltage	Hz	Frame Size
APH0016-841	AEHH8B	1	1200	460	60	145T

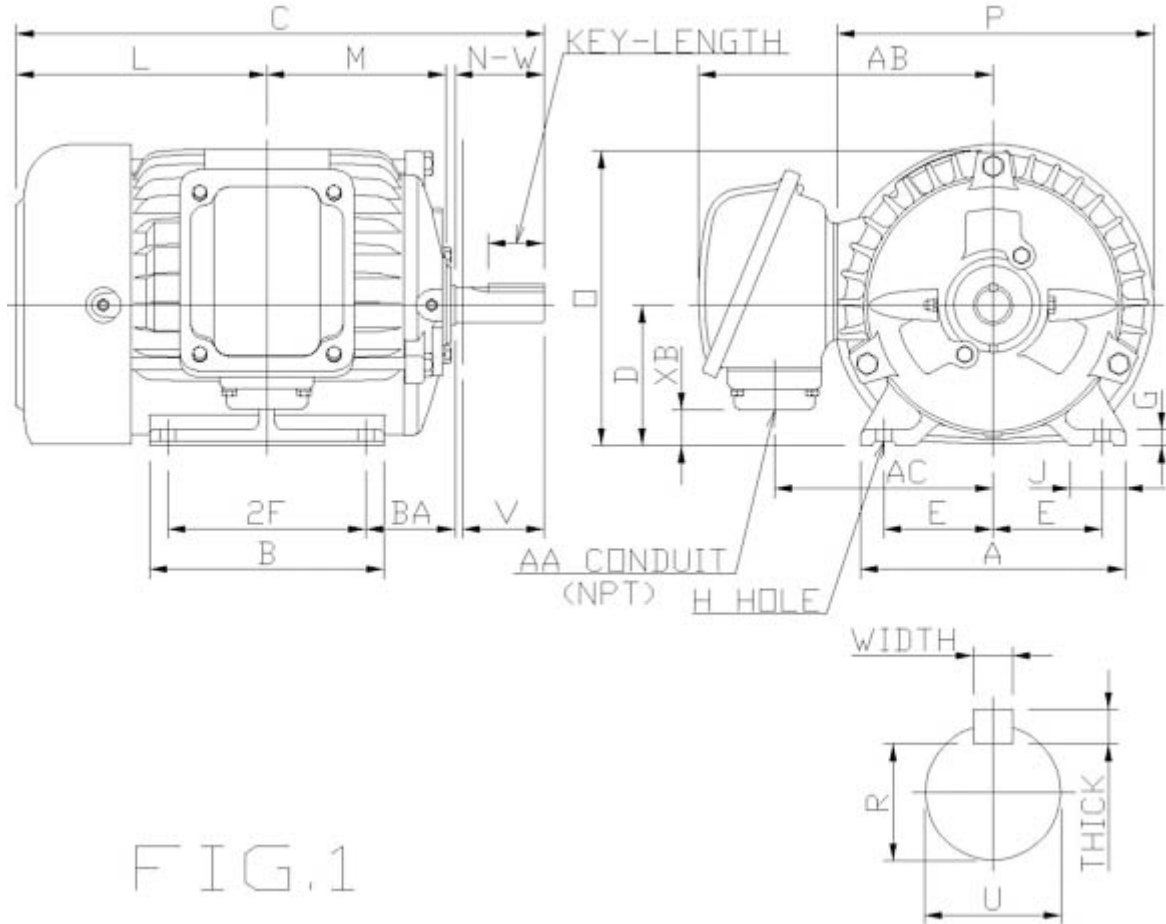

FIG.1



Mounting					A	B	C	CL1	CL2	D	G
E	2F1	2F2	H	BA							
2.75	5	4	0.34	2.25	6.7	5.1	13.54			3.5	0.35

J	K	L	M	O	P	T
1.4		6.54	4.53	7.48	7.95	

Terminal Housing			
AA	AB	AC	XB
NPT3/4"	7.56	5.63	0.86

Shaft Extension			Key			Keyseat
N-W	U	V	Width	Thick	Length	R
2.25	0.875	2.2	0.188	0.188	1.41	0.771

Bearings		Weight Lbs	Drive Method	Dimensions
DE	NDE			
6205ZC3	6205ZC3	59	Direct Coupling / Belt Drive	Inches

	Beaver Electrical Machinery	
	Date: June 7, 2022	

### Technical Data Sheet

Motor Type: AEHH8B	Catalogue No: APH0016-841
--------------------	---------------------------

#### Nameplate Information

HP	Pole	RPM	Frame	Voltage	Hz	Phase
1	6	1150	145T	460	60	3
Enclosure	Ins. Class	Service Factor	Time Rating	NEMA Design	Rated Amb.	Rated Altitude
TEFC	F	1.15	Continuous	B	-40 to 40 °C	<1000 m

#### Typical Performance

Efficiency (%)				Power Factor (%)		
Full Load		3/4 Load	1/2 Load	Full Load	3/4 Load	1/2 Load
Nom.	Min.					
82.5	80	82.5	80	65.5	57	44.5
Torque				Current (A)		
Full Load (lb-ft)	Locked Rotor (% FLT)	Pull Up (% FLT)	Break Down (% FLT)	No Load	Full Load	Locked Rotor
4.57	250	220	300	1.2	1.7	15
NEMA KVA Code	Inertia (WR <sup>2</sup> )			Safe Stall Time (s)		Noise Level Sound Press. dB(A)
	Rotor (lb-ft <sup>2</sup> )	NEMA Load (lb-ft <sup>2</sup> )	Max. Allowable (lb-ft <sup>2</sup> )	Cold	Hot	
N	0.122	15	100	60	42	50

#### VFD Duty Information

Max HP	Current (A)	Speed Range		VFD		S.F.
		Constant Torque	Variable Torque	Carrier Hz	Type	
1	1.73	6-60Hz	3-60Hz	3-6kHz	VPWM or CPWM	1

#### Hazardous Locations Information



CSA Certified
Class I, Div 2, Groups B, C & D Class I, Zone 2, Groups IIB+H2, IIB & IIA
Temp Code (Sinewave / VFD)
T3C / T3C

#### Additional Certifications

Other Certification
---------------------

#### Additional Information

Bearings		Approx. Weight
DE	NDE	lbs
6205ZC3	6205ZC3	59

	Beaver Electrical Machinery	
	Date: June 7, 2022	

### Nameplate Drawing

Advantage Plus IEEE 841					
TYPE	AEHH8B	CAT. NO.	APH0016-841		
OUTPUT	1 HP 0.75 kW	FRAME	145T	TEFC	
R.P.M.	1150	POLE	6	INS.	F
VOLTS	460	PHASE	3	Hz	60
AMPS	1.7	CODE	N	S.F.	1.15
AMBIENT	40 °C	NOM. EFF. 82.5		MIN. EFF. 80	
BEARINGS	6205ZC3 / 6205ZC3			RATING Cont.	
SER. NO.	TBD	DESIGN	B	WT. 59 LBS	
PWM VFD DUTY	VT	CT	CP	S.F.	
	3-60Hz	6-60Hz	60-120Hz	1	



### Connection Diagram

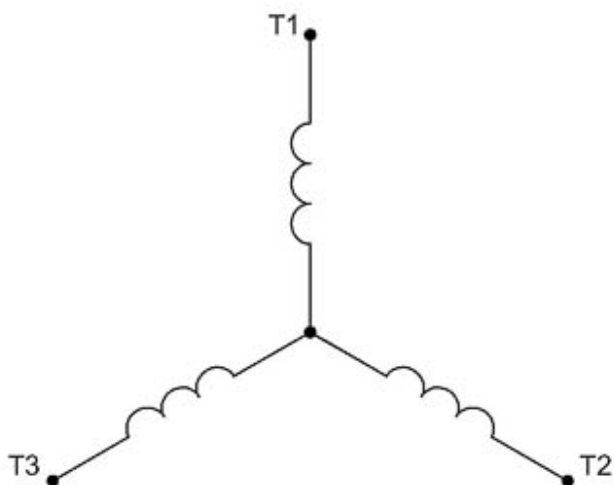

3 LEAD		SINGLE VOLTAGE			WYE
VOLTAGE	CONN.	L1	L2	L3	
-	WYE	1	2	3	

WD\_3Y



### Thermal Limit Curves

Motor Type: AEHH8B		Catalogue No: APH0016-841		Family: Advantage Plus IEEE 841	
HP	1	Safe Stall Time		Full Load A	1.7 A
Voltage	460V 60Hz	Hot	42 s	% Inrush	867 %
RPM	1200	Cold	60 s	Locked Rotor A	15 A

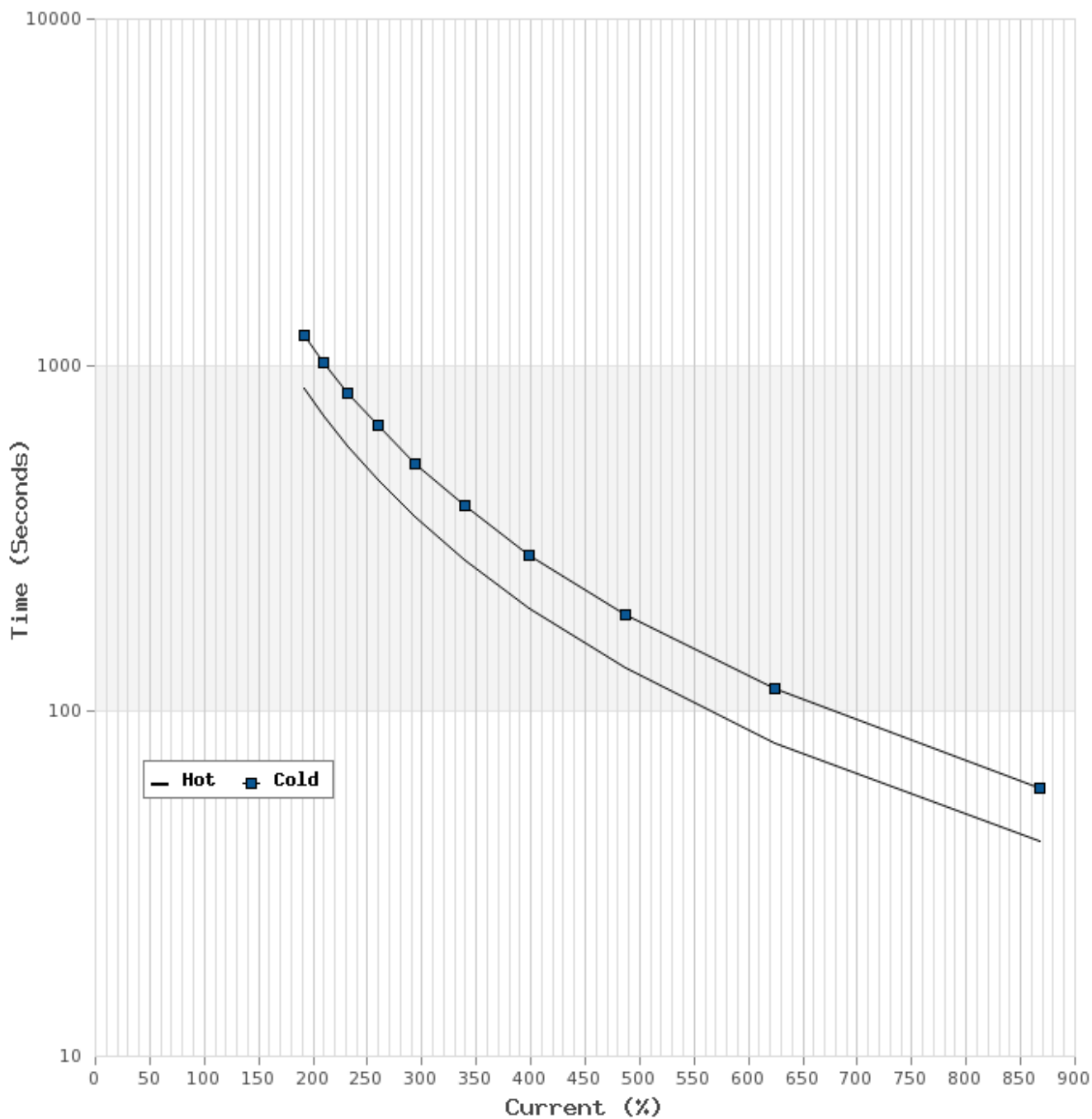



### T-N and I-N Curves

Motor Type: AEHH8B		Catalogue No: APH0016-841		Family: Advantage Plus IEEE 841	
HP	1	Full Load T	4.57 lb-ft	Full Load A	1.7 A
Voltage	460V 60Hz	Locked Rotor T	250 %	Locked Rotor A	15.0 A
RPM	1200	Pull Up T	220 %	Break Down T	300 %

