



Technical Documentation

# **APH00145C-841**

## **Advantage Plus IEEE 841 | AEHH8B**

Beaver Electrical Machinery Ltd.

Date: July 25, 2022



**Dimensional Drawing**

Catalogue	Type	HP	RPM	Voltage	Hz	Frame Size
APH00145C-841	AEHH8B	1	1800	575	60	143TC

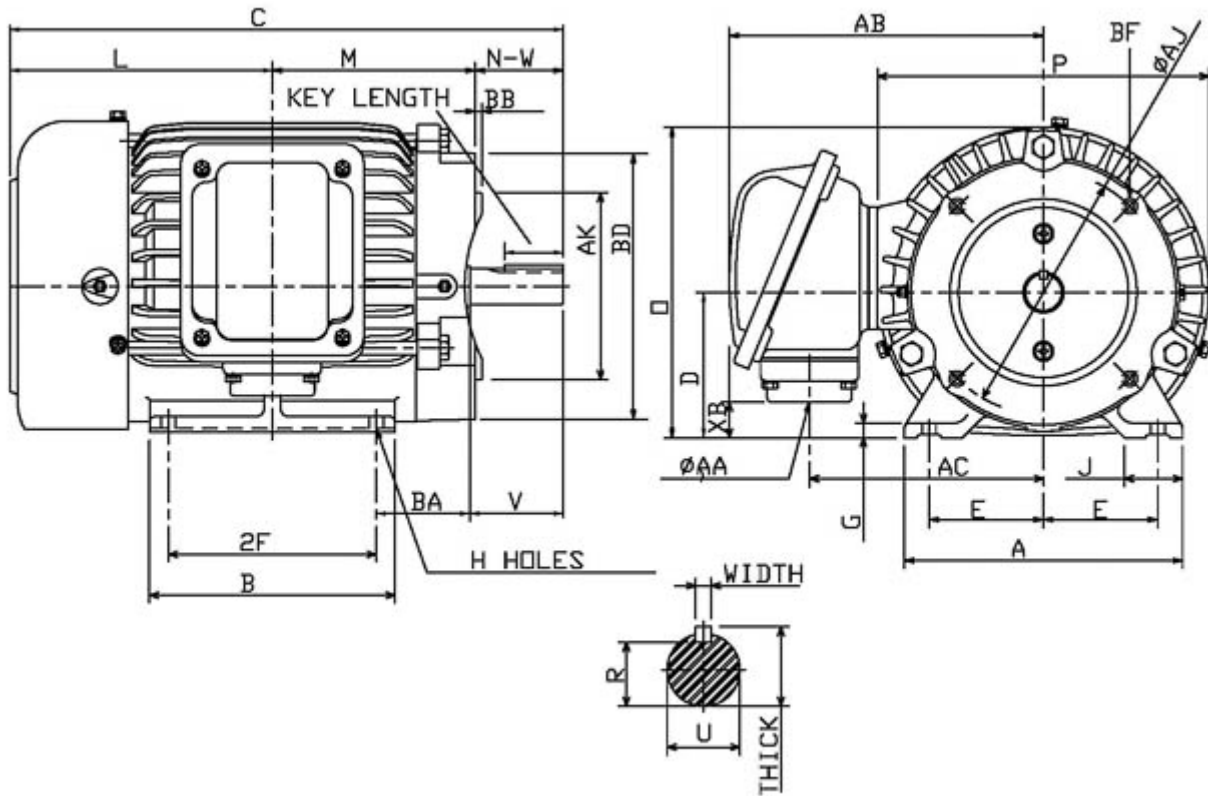



Mounting					A	B	C	CL1	CL2	D	G
E	2F1	2F2	H	BA							
2.75	4		0.34	2.25	6.7	5.1	12.34			3.5	0.35
J	K	AK	AJ	L	M	O	P	T	BD	BB	BF
1.4		4.5	5.875	5.84	4.03	7.48	7.97		6.4	0.16	3/8-16UN C

Terminal Housing			
AA	AB	AC	XB
3/4 NPT	7.56	5.63	0.86

Shaft Extension			Key			Keyseat
N-W	U	V	Width	Thick	Length	R
2.25	0.875	2.2	0.188	0.188	1.41	0.771

Bearings		Weight Lbs	Drive Method	Dimensions
DE	NDE			
6205ZC3	6205ZC3	55	Direct Coupling / Belt Drive	Inches

	Beaver Electrical Machinery Ltd.	
	Date: July 25, 2022	

### Technical Data Sheet

Motor Type: AEHH8B	Catalogue No: APH00145C-841
--------------------	-----------------------------

#### Nameplate Information

HP	Pole	RPM	Frame	Voltage	Hz	Phase
1	4	1745	143TC	575	60	3
Enclosure	Ins. Class	Service Factor	Time Rating	NEMA Design	Rated Amb.	Rated Altitude
TEFC	F	1.15	Continuous	B	-40 to 40 °C	<1000 m

#### Typical Performance

Efficiency (%)				Power Factor (%)		
Full Load		3/4 Load	1/2 Load	Full Load	3/4 Load	1/2 Load
Nom.	Min.					
85.5	82.5	84	81.5	73	64.5	51.5
Torque				Current (A)		
Full Load (lb-ft)	Locked Rotor (% FLT)	Pull Up (% FLT)	Break Down (% FLT)	No Load	Full Load	Locked Rotor
3.01	310	280	410	0.6	1.2	12
NEMA KVA Code	Inertia (WR <sup>2</sup> )			Safe Stall Time (s)		Noise Level Sound Press. dB(A)
	Rotor (lb-ft <sup>2</sup> )	NEMA Load (lb-ft <sup>2</sup> )	Max. Allowable (lb-ft <sup>2</sup> )	Cold	Hot	
N	0.086	5.8	46	71	50	49

#### VFD Duty Information

Max HP	Current (A)	Speed Range		VFD		S.F.
		Constant Torque	Variable Torque	Carrier Hz	Type	
1	1.2	6-60Hz	3-60Hz	3-6kHz	VPWM or CPWM	1

#### Hazardous Locations Information



CSA Certified
Class I, Div 2, Groups B, C & D Class I, Zone 2, Groups IIB+H2, IIB & IIA
Temp Code (Sinewave / VFD)      T3C / T3C

#### Additional Certifications

Other Certification
---------------------

#### Additional Information

Bearings		Approx. Weight
DE	NDE	lbs
6205ZC3	6205ZC3	55

	Beaver Electrical Machinery Ltd.	
	Date: July 25, 2022	

### Nameplate Drawing

Advantage Plus IEEE 841					
TYPE	AEHH8B		CAT. NO.	APH00145C-841	
OUTPUT	1 HP 0.75 kW		FRAME	143TC	TEFC
R.P.M.	1745		POLE	4	INS. F
VOLTS	575		PHASE	3	Hz 60
AMPS	1.2		CODE	N	S.F. 1.15
AMBIENT	40 °C		NOM. EFF. 85.5		MIN. EFF. 82.5
BEARINGS	6205ZC3 / 6205ZC3				RATING Cont.
SER. NO.	TBD		DESIGN	B	WT. 55 LBS
PWM VFD DUTY	VT	CT	CP	S.F.	
	3-60Hz	6-60Hz	60-120Hz	1	



### Connection Diagram

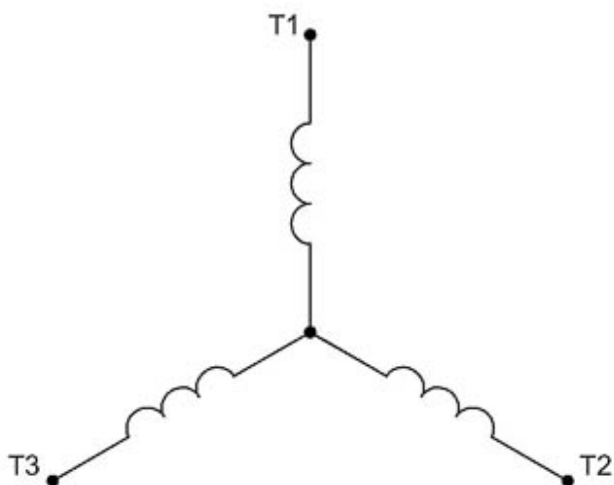

3 LEAD		SINGLE VOLTAGE			WYE
VOLTAGE	CONN.	L1	L2	L3	
-	WYE	1	2	3	

WD\_3Y



### Thermal Limit Curves

Motor Type: AEHH8B		Catalogue No: APH00145C-841		Family: Advantage Plus IEEE 841	
HP	1	Safe Stall Time		Full Load A	1.2 A
Voltage	575V 60Hz	Hot	50 s	% Inrush	1,000 %
RPM	1800	Cold	71 s	Locked Rotor A	12 A

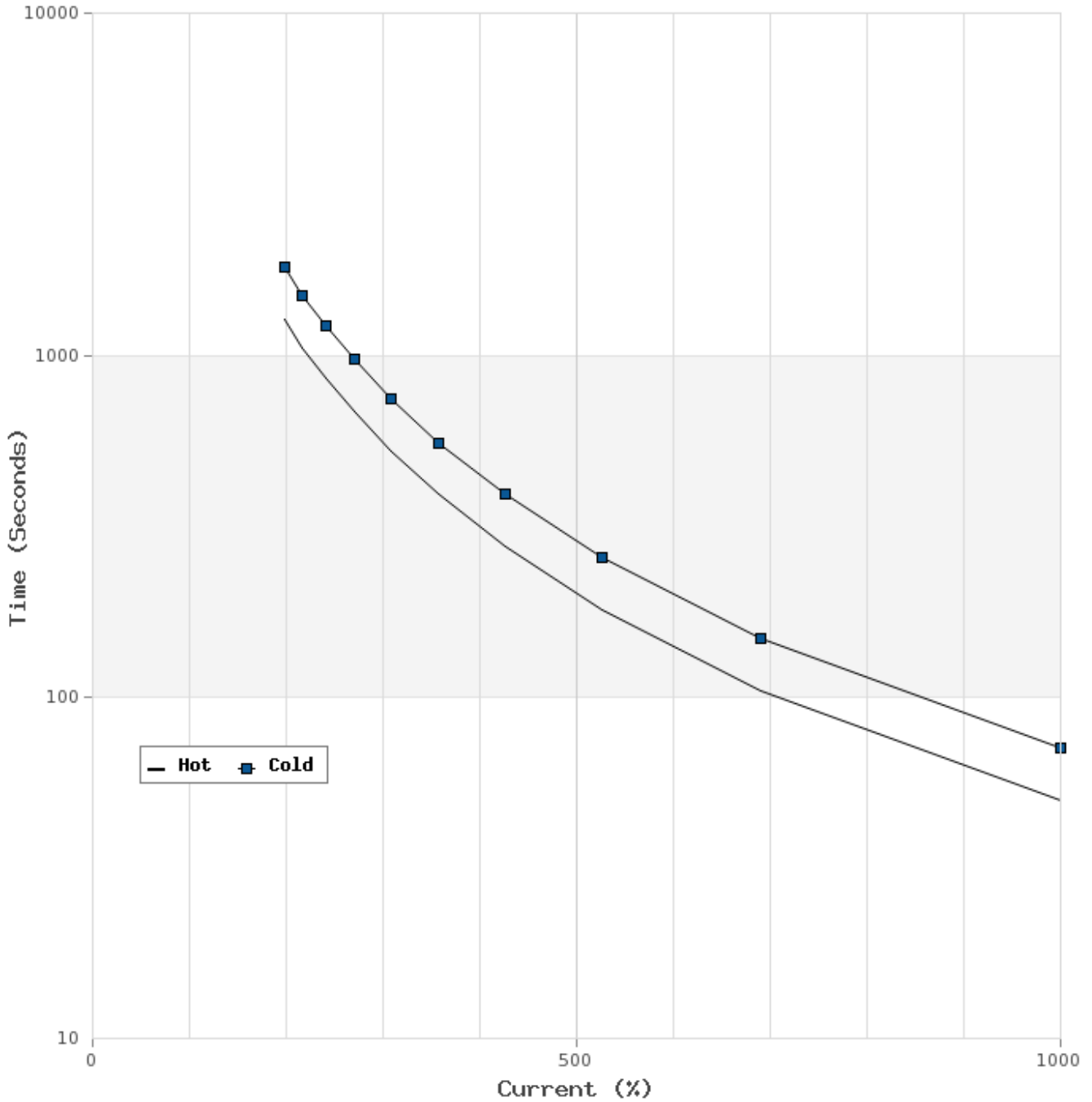



**T-N and I-N Curves**

Motor Type: AEHH8B		Catalogue No: APH00145C-841		Family: Advantage Plus IEEE 841	
HP	1	Full Load T	3.01 lb-ft	Full Load A	1.2 A
Voltage	575V 60Hz	Locked Rotor T	310 %	Locked Rotor A	12.0 A
RPM	1800	Pull Up T	280 %	Break Down T	410 %

